

2015-2017 Domestic Competition Regulations as Presented by USA Volleyball

**Rules of the Game as authorized by the
International Volleyball Federation at the
XXXIVth FIVB World Congress, Cagliari,
Italy, 2014 and amended.**

Editor: Kinda S. Lenberg

Editor: Rick Laskey

Scoring Editor: Ric Washburn

Published by USA Volleyball

USA Volleyball has officially approved the modifications presented in this document in order to **promote the sport and encourage continuity of play** at the various organizational, local and recreational levels across the country.

For the official international rules of the game, which are used worldwide and developed and approved by the FIVB (Federation Internationale de Volleyball), please visit www.fivb.org or our web site at www.usavolleyball.org.

Printed by FuseCreates, Denver, Colo.

USA Volleyball
4065 Sinton Road, Ste. 200
Colorado Springs, CO 80907-5096
(719) 228-6800
www.usavolleyball.org

Copyright © 2015 by USA Volleyball
ISBN: 0-9704491-1-9



Printed on 10% post-consumer waste recycled paper



Volleyball Associations/Federations worldwide endeavor to provide equal opportunities and maximum enjoyment for participants and spectators, maintaining the values of fair play and peaceful involvement.

USA Volleyball embraces this view, joining with all of its global partners to enable pleasurable participation from the broadest base of recreational play, to the highest levels of international competition. Volleyball can enrich the lives of all who play and watch it. It should be fun.

WE COMMIT THE RULES TO THIS END.



ACKNOWLEDGMENTS

The Rules Commission and USA Volleyball would like to express their appreciation to the many individuals and organizations for their assistance in the editing of and providing information for this publication.

Official Hand Signals courtesy of the Federation Internationale de Volleyball, © 2014 FIVB.

Diagrams 1-10 reproduced by authorization of the Federation Internationale de Volleyball, ©2014, FIVB.

Special thanks go to Rick Laskey, Nancy Funk, Ric Washburn, Lynne Updegraff, Jennifer Williams, Kathy Ferraraccio, Michael McPoyle, Marcia Alterman and Connie Laskey.

Suggested Retail Price: \$6.95

INDOOR VOLLEYBALL RULES
COVER DESIGN BY DESIGN RANGERS, INC.

TABLE OF CONTENTS

Rules Commission	ix
Significant Rule Changes	xii
Game Characteristics	1
Philosophy of Rules and Refereeing	1
Spectator/Parent Code of Conduct	3

DOMESTIC COMPETITION REGULATIONS ORDER OF THE RULES

SECTION I THE GAME

Chapter One: Facilities and Equipment	
Rule 1. Playing Area	4
Rule 2. Net and Posts	7
Rule 3. Balls	9
Chapter Two: Participants	
Rule 4. Teams	11
Rule 5. Team Leaders	15
Chapter Three: Playing Format	
Rule 6. To Score a Point, To Win a Set and the Match	19
Rule 7. Structure of Play	20
Chapter Four: Playing Actions	
Rule 8. States of Play	25
Rule 9. Playing the Ball	26
Rule 10. Ball at the Net	28
Rule 11. Player at the Net	29
Rule 12. Service	31
Rule 13. Attack Hit	34
Rule 14. Block	35
Chapter Five: Interruptions, Delays and Intervals	
Rule 15. Interruptions	38
Rule 16. Game Delays	43
Rule 17. Exceptional Game Interruptions	43
Rule 18. Intervals and Change of Courts	45

Chapter Six: The Libero Player	
Rule 19. The Libero Player	46

Chapter Seven: Participants' Conduct	
Rule 20. Requirements of Conduct	51
Rule 21. Misconduct and Its Sanctions	51

SECTION II THE REFEREES, THEIR RESPONSIBILITIES AND OFFICIAL HAND SIGNALS

Chapter Eight: Referees	
Rule 22. Refereeing Corps and Procedures	55
Rule 23. 1 st Referee	56
Rule 24. 2 nd Referee	58
Rule 25. Scorer	60
Rule 26. Assistant Scorer	62
Rule 27. Line Judges	63
Rule 28. Official Signals	64

SECTION III DIAGRAMS

Court Diagrams	65
Official Hand Signals	76
Definitions	85
U-Volley Rules	87
Co-Ed Rules	87
Guide to Physically Challenged Volleyball	90

TECHNIQUES, MECHANICS & PROCEDURES

Referee Techniques	95
Referee Points of Emphasis	102

INSTRUCTIONS FOR SCORERS USING THE OFFICIAL INDOOR SCORE SHEETS

Instructions	105
National Championship Tournaments Procedures Only	149
Assistant Scorer Responsibilities	150
Explanation of Scoring Example	163
Non-Deciding Set Scoring Procedures	163
Deciding Set Scoring Procedures	181

BASIC PROCEDURES AND PRE-MATCH PROTOCOLS

Basic Procedures For Conducting a USA Volleyball Match/ Competition For Referees	195
Pre-Match Protocols	199
Guidelines for Conducting Indoor Tournaments/Leagues	201
Guidelines for Dealing With Blood	213
Abbreviations	213
Metric Conversions	214

INDEX TO THE RULES

Official Indoor Rules	215
U-Volley Rules	220
Co-Ed Rules	220

MODIFICATIONS

For all designated international competitions, the FIVB rules will be fully in effect. In addition, the original FIVB rules are used at the highest levels of competition (such as Adult Opens, PVL and High Performance) unless otherwise noted in the Specific Competitions Regulations. Modifications in the gray boxes apply to all other levels of competition.

EXAMPLE:

USAV 1.1a: The free zone may be a minimum of 2 m (6'6 3/4"). It is not required that the free zone be symmetrical.

USA Volleyball recognizes that there are circumstances where grassroots development, sport development, safety or insurance requirements would indicate a need for a temporary rule modification (e.g., the number of substitutions might be expanded to include more participants at a school or recreational level).

Acknowledging that a rule may not be changed, in instances where the USAV member organizations feel that the promotion of the sport would be enhanced by temporary adjustments, they are encouraged to promote the advancement of the sport.

Suggestions for additional changes or temporary adjustments for inclusion in this document may be transmitted through members of the Rules Commission, regional officials chairpersons or commissioners during the season. Explanation and rationale of proposed modifications must be in the chair's hands before **Feb. 1, 2016**, if they are to be considered at the 2016 annual meeting of the Rules Commission and before **Feb. 1, 2017** if they are to be considered at the 2017 annual meeting.

RULES INTERPRETATION

Questions regarding interpretation of the present rules and current practices may be addressed to: USA Volleyball Rules Interpreter Paul Albright, 708 Planters Row, Lilburn, GA 30047, Phone: Res (770) 367-7792, E-mail: vbinterp@usav.org. Contact by e-mail is preferred (vbinterp@usav.org); however, you may enclose a self-addressed, stamped envelope with your inquiry for prompt return. All inquiries will receive replies. Some queries may involve consultations, but answers will be forwarded as soon as possible.

For information relevant to the interpretation and application of the rules-specific match situations, please consult the *USA Volleyball Web site* at **www.usavolleyball.org**.

INFORMATION FOR HEARING-IMPAIRED VOLLEYBALL PLAYERS

For additional information on the USA Deaf Volleyball Association or USA Deaf Sports Federation, contact:

Patrick O'Brien

PO Box 2193, Bowie, MD 20718-2193

Email: pobrien@usadeafsports.org

or

USA Deaf Sports Federation

PO Box 910338, Lexington, KY 40591-0338

E-mail: homeoffice@usdeafsports.org

Web Site: www.usdeafsports.org/volleyball

TT (605) 367-5761, (605) 367-5760, FAX: (605) 782-8441

Dial 711 for voice calls and give relay operator the TT number above. To obtain a copy of *Volleyball in American Sign Language*, which illustrates more than 40 of the most important volleyball terms, contact USA Volleyball at 855-USVOLLEY or info@usav.org.

INFORMATION FOR PHYSICALLY CHALLENGED VOLLEYBALL PLAYERS

For additional information on the Men's and Women's Standing and Sitting Volleyball National Programs for the physically challenged, contact:

Bill Hamiter, High Performance Director, Sitting Program

Head Coach Women's National Sitting Team

100 N. University Drive, Box 99

Edmond, OK 73034

Phone: (405) 974-3138; Fax: (405) 974-3808

E-mail: bill.hamiter@usav.org

For additional information on grassroots programs (find a place to play, create a new program, etc.), contact:

Elliot Blake, Sitting Volleyball Coordinator

100 N. University Drive, Box 99

Edmond, OK 73034

Phone: (405) 974-3153; FAX: (405) 974-3808

Email: elliott.blake@usav.org

**INFORMATION FOR SPECIAL OLYMPICS
VOLLEYBALL PLAYERS**

For additional information on Special Olympics Traditional, Modified and Unified® Sports Team Volleyball and Individual Skills Volleyball Programs, please contact:

Special Olympics North America

Craig Pippert

3712 Benson Dr., Suite 102

Raleigh, NC 27609

(919) 785-0702, FAX: (919) 782-3311

Email: cpippert@specialolympics.org

**USA VOLLEYBALL
RULES COMMISSION
VOLLEYBALL COMMITTEE
2015**

***Chair:** Pati Rolf, N27W27442 Woodland Dr., Pewaukee, WI 53072
(Phone: 262-510-6771, Cell: 262-510-6771, Email: pati.rolf@gmail.com)

***USA Volleyball Beach Officials Representative:** Steve Owen,
894 Elmwood Dr., Abilene, TX 79605 (Phone: 325-676-0721,
Cell: 325-668-3484, Email: swowen2@suddenlink.net)

***USA International Referees Commission Representative:**
Steve Robb, 2412 Liles Ln., Mesquite, TX 75181 (Cell: 469-371-8057,
Email: srobbusav@aol.com)

***FIVB Referee Commission:** Doug Wilson, 1100 Hondo Ct., Castle
Rock, CO 80104 (Cell: 719-651-2797, Email: doug.wilson1968@gmail.com)

***FIVB Rules of the Game Commission:** Pat Powers, 153 Phoebe
Street, Encinitas, CA 92024 (Phone:760-635-3994; Cell: 760-473-8236,
Email: pat@vbclinics.com)

***USA Volleyball Rules Interpreter:** Paul Albright, 708 Planters
Row, Lilburn, GA 30047 (Phone: 770-367-7792,
Email: albright09@comcast.net or vbinterp@usav.org)

***USA Volleyball Beach Rules Interpreter:** Glenn Sapp, 7950
Dudley Ct., Arvada, CO 80005 (Cell: 720-289-5797,
FAX: 303-782-5577, Email: sappvb@aol.com)

***USA National Indoor Referees Representative:** Dave
Spencer, 4601 Birch Creek Dr., Lincoln, NE 68516 (Cell: 402-430-4899,
Email: usavrefchair@neb.rr.com); Second Rep: Michael McPoyle, 105
Helm Way, Downingtown, PA 19335 (Phone: 610-669-2641,
Cell: 484-678-3621, Email: referee@krva.org)

***USA National Indoor Scorers Representative:** Nancy Funk,
7906 Ferndale Rd., Louisville, KY 40291 (Phone: 502-239-1818,
Cell: 502-299-1820, FAX: 502-290-9480, Email: nfunk@twc.com)

***USA Volleyball Regional Volleyball Association**

Representative: Kevin Wendelboe, 3770 Clemmons Rd., Suite C, Clemmons, NC 27012 (Phone: Work: 336-766-3581, FAX: 336-766-3501, Email: ceo@carolinaregionvb.org)

***World ParaVolley:** Joe Campbell, 16305 Lewis St., Jersey Village, TX 77040 (Phone: Home: 713-856-5565, Cell: 713-702-9516, FAX: 713-849-6759, Email: iokepa1@yahoo.com)

***Junior Indoor Coach Representative:** Walt Weaver, 16616 Isosceles Ave., Lakeville, MN 55044 (Phone: 952-892-1721, Cell: 612-720-4278, Email: weavermvi@charter.net)

***AAU Representative:** Joyce Cooney, 6816 Cottage Grove Lane, Apt. D, St. Louis, MO 63129-3953 (Phone: 314-846-5149, Email: acevbc@aol.com)

NAIA Men's Representative: Donan Cruz, Grandview University, 1200 Grandview Ave., Des Moines, IA 50316 (Phone: Work: 515-263-6137, Cell: 808-386-2318, Email: dcruz@grandview.edu)

***NCAA Men's Representative:** Ron Shayka, George Mason University, 4400 University Dr., Fairfax, VA 22030 (Phone: 703-993-2809, FAX: 703-993-3533, Email: rshayka@gmu.edu)

***NCVF Representative:** Dan Kitchel, 1710 Stirling Ave., Lansing, MI 48910 (Phone: 517-372-2204, Cell: 517-449-5431, Email: dkitchel@ncvfvolleyball.org) represented by Ric Washburn, 433 Valley View Ct., Jefferson City, MO 65109 (Phone: 573-635-8508, Cell: 573-230-8694, Email: ric.ncvf@all-vball.net)

***Special Olympics Incorporated Representative:** Rick Laskey, 128 Troy Avenue, Jacksonville, NC 28540 (Phone: 910-545-9171, Email: rlaskey@earthlink.net)

NFHS Representative: Becky Oakes, NFHS, P.O. Box 690, Indianapolis, IN 46206 (Phone: 317-822-5739, FAX: 317-822-5700, Email: boakes@nfhs.org)

NCAA Women's Representative: Anne Pufahl, 205 Glenview Ave., Wauwatosa, WI 55213 (Phone: 414-430-0111, Email: anne.pufahl@marquette.edu)

PAVO Representative: Julie Voeck, 6905 Wellauer Dr., Wauwatosa, WI 53213 (Phone: 414-305-7454, Email: jvoeck@attglobal.net)

YMCA Representative: Ben Reed, YMCA of the USA, 101 N. Wacker Dr., Chicago, IL 60606 (Phone: Work: 800-872-9622, x9622) represented by Nicole Limoges, YMCA of Metro Denver, 2625 S. Colorado Blvd., Denver, CO 80210 (Phone: 303-639-4712, Email: nlimoges@denverymca.org)

USA Volleyball Indoor Officials Consultant: Kathy Ferraraccio, 66A Congamond Road, Southwick, MA 01077 (Phone: 413-569-6970, Email: kathy@ferraracio.com)

USA Volleyball Staff Liaison: Margie Mara, USA Volleyball, 4065 Sinton Road, Suite 200, Colorado Springs, CO 80907 (Phone: 719-228-6800, Cell: 719-310-5763, FAX: 719-228-6899, E-mail: margie.mara@usav.org)

*17 voting members

2015-2017 DOMESTIC COMPETITION REGULATIONS SIGNIFICANT VOLLEYBALL (INDOOR) RULE CHANGES AND CLARIFICATIONS

2015-2016 FIVB Rule Changes for Indoor Volleyball

4.5.3 Compression pads (padded injury protection devices) may be worn for protection or support.

For FIVB, World and Official competitions for Seniors, these devices must be of the same color as the corresponding part of the uniform.

6.1.3 Rally and completed rally

A rally is the sequence of playing actions from the moment of the service hit by the server until the ball is out of play. A **completed rally** is the sequence of playing actions which results in the award of a point. **This includes the award of a penalty and loss of service for serving faults outside the time limit.**

8.3 BALL "IN"

The ball is "in" if at any moment of its contact with the floor, some part of the ball touches the court, including the boundary lines.

11.3 CONTACT WITH THE NET

11.3.1 Contact with the net by a player between the antennae, during the action of playing the ball, is a fault. The action of playing the ball includes (among others) take-off, hit (or attempt) and landing.

11.4 PLAYER'S FAULTS AT THE NET

11.4.4. A player interferes with play by (amongst others):

- touching the net between the antennae or the antenna itself during his/her action of playing the ball,
- using the net between the antennae as a support or stabilizing aid
- creating an unfair advantage over the opponent by touching the net
- making actions which hinder an opponent's legitimate attempt to play the ball,
- catching/holding on to the net.

Players close to the ball as it is played, or who are trying to play it, are considered in the action of playing the ball, even if no contact is made with the ball.

However, touching the net outside the antenna is not to be considered a fault (except for Rule 9.1.3).

19.1 DESIGNATION OF THE LIBERO

19.1.1. Each team has the right to designate from the list of players on the score sheet up to two specialist defensive players: Liberos.

2015-2016 USAV Rule Changes for Indoor Volleyball

New USAV 4.1.2: One of the players is the team captain, who shall be indicated on the score sheet.

New USAV 4.1.3b: At least 10 minutes before the start of each match, including tournament play, each team shall submit a roster listing the names and uniform numbers of players eligible to participate in the match. The coach or team captain must sign the roster. A roster may be changed at any time during the match, but only to correct a uniform number. However, if the coach or game captain requests such a number change, that team will be charged with a penalty point. A roster may not be changed to add a player at any time after having been signed by the coach or team captain.

New USAV 4.3.3: The players' jerseys must be numbered in a permanent manner from 1 to 99 using Arabic numerals. Duplicate numbers are not allowed.

New USAV 5: The Libero **CAN** be team captain, game captain or both.

New USAV 5.1.2: When the team captain is not on the court, the coach or the team captain must assign another player on the court to assume the role of game captain.

New USAV 5.1.2.1: If an explanation of an application or interpretation of a rule is not satisfactory to the game captain, he/she must immediately indicate his/her disagreement and file an official protest prior to the authorization of the next service. If the disagreement with the referees' explanation involves the last point of the set, the official protest must be recorded within the first 60 seconds of the timed interval between sets. If the final point of the match is disputed, the protest must be recorded within the first 60 seconds after the final point of the match is scored. (Protest is ruled upon by the Championship Committee either immediately or prior to the start of the next set.) It is advisable to have an assigned Protest Committee available to rule upon a protest as soon as possible prior to the first service following the protest. Such action should preclude playing the match over from the point of protest if the protest is upheld. Protests considered by the 1st referee (Protest or Tournament Committee) include: 1) misinterpretation of a playing rule, 2) failure of the 1st referee to apply the correct rule to a given situation, or 3) failure to

charge the correct penalty-sanction for a given fault. Protest facts recorded on the score sheet include the: 1) score of the set at the time of the protest, 2) players and positions at the time of the protest, 3) player substitutions and team substitutions made up to the protest, 4) team time-outs taken up to the protest, 5) situation that caused the protest, and 6) signatures of the scorer, captains and 1st referee, indicating the facts are correct.

New USAV 5.1.3: The captain does not sign the score sheet after the match. It is no longer required that either coach sign the score sheet after the match to verify the results.

Delete USAV 7.2.2c (USAV 7.2.2 describes suggested warm-up protocols, and sections a and b are still in effect.)

New USAV 8.4.2f: If an official, media equipment or personnel or spectator interferes with a player's legal attempt to play the ball over the playing area, a playover shall be directed.

New USAV 17.3.2: For tournament play where a court change is necessitated, the match will be continued from the point of the interruption.

New USAV 17.3.2.2: If the match is resumed on another playing court, the interrupted set shall continue normally with the same score, players (except expelled or disqualified ones) and positions. The sets already played will keep their scores.

New USAV 19.1.1: Each team has the right to designate from the list of players on the score sheet (roster) up to two specialized defensive players called Liberos. If the team chooses to designate two Liberos at the start of the match, they are designated as Liberos for the entire match. If the team chooses to designate only one Libero (or no Libero) at the start of the match, the team may choose to change the player designated as Libero for each set including playing any set with no Libero, but may not designate a second Libero for any subsequent set in the match.

New USAV 19.4.2.5: If the coach requests the team captain to be re-designated as the new Libero, this will be permitted and the team captain retains all leadership privileges.

New USAV 25.2.3.3: The 2nd referee is not required to sign the score sheet(s). It is no longer required that either coach sign the score sheet after the match to verify the results.

In recent years, the FIVB has made great strides in adapting the game to a modern audience.

This text is aimed at a broad volleyball public – players, coaches, referees, spectators or commentators – for the following reasons:

- Understanding the rules better allows better play – coaches can create better team structure and tactics, allowing players full rein to display their skills;
- Understanding the relationship between rules allows officials to make better decisions.

This introduction at first focuses on Volleyball as a competitive sport, before setting out to identify the main qualities required for successful refereeing.

Volleyball is a Competitive Sport

Competition taps latent strengths. It exhibits the best of ability, spirit, creativity and aesthetics. The rules are structured to allow all of these qualities. With a few exceptions, volleyball allows all players to operate both at the net (in attack) and in the back of the court (to defend or serve).

William Morgan, the game's creator, would still recognize it because volleyball has retained certain distinctive and essential elements over the years. Some of these it shares with other net/ball/racquet games:

- service
- rotation (taking turns to serve)
- attack
- defense.

Volleyball is, however, unique amongst net games in insisting that the ball is in constant flight – a flying ball – and by allowing each team a degree of internal passing before the ball must be returned to the opponents.

The introduction of a specialist defensive player – the Libero – has moved the game forward in terms of rally length and multi-phase play. Modifications to the service rule have changed the act of service from simply a means of putting the ball in play to an offensive weapon.

The concept of rotation is entrenched to allow for all-around athletes. The rules on player positions must permit teams to have flexibility and to create interesting developments in tactics. Competitors use this framework to contest techniques, tactics and power. The framework also allows players a freedom of expression to enthuse spectators and viewers.

And the image of Volleyball is increasingly a good one. As the game evolves, there is no doubt that it will change – even better, stronger and faster.

The Referee Within This Framework

The essence of a good referee lies in the concept of fairness and consistency:

- To **be** fair to every participant;
- To be **viewed** as fair by the spectators.

This demands a huge element of trust – the referee must be trusted to allow the players to entertain:

- by being **accurate** in his/her **judgment**;
- by understanding why the rule is written**;
- by being an **efficient organizer**;
- by allowing the competition to flow and by **directing** it to a conclusion;
- by being an **educator** – using the rules to penalize the unfair or admonish the impolite;
- by **promoting** the game – that is, by **allowing the spectacular** elements in the game to shine and the best players to do what they do best: **entertain** the public.

Finally, we can say that a good referee will use the rules to make the competition a fulfilling experience for **all** concerned.

To those who have read thus far, view the Rules that follow as the current state of development of a great game, but keep in mind why these preceding few paragraphs may be of equal importance to you in your own position within the sport.

Get involved!
Keep the ball flying!

SPECTATOR/PARENT CODE OF CONDUCT

I WILL:

1. I WILL abide by the official rules of USA Volleyball.
2. I WILL display good sportsmanship at all times.
3. I WILL educate myself on the unique rules of this facility and abide by them.
4. I WILL generate goodwill by being polite and respectful to those around me at this event.
5. I WILL immediately notify the Event Director and/or Program Administrator in the event that I witness any illegal activity.
6. I WILL acknowledge that the spectator seating around the courts is for the primary use of those watching the match in progress.
7. I WILL acknowledge that spectators may rightfully choose to remain in a seat for an entire match without switching sides of the court when the teams switch.

I WILL NOT

1. I WILL NOT harass or intimidate the officials, including line judges and scorers.
2. I WILL NOT participate in any game or game-like activities unless I have a current membership with USA Volleyball.
3. I WILL NOT bring and/or carry any firearms at any USA Volleyball event.
4. I WILL NOT bring, purchase, or consume alcohol at any Youth/ Junior volleyball event.

WARNING!

Injury from flying objects incidental to the sport of volleyball may occur at this event. Attend at your own risk. Please pay close attention to your surroundings and be alert at all times, especially during active play.

SECTION I - THE GAME

CHAPTER 1 FACILITIES AND EQUIPMENT

See Rules

1 PLAYING AREA

The playing area includes the playing court and the free zone. It shall be rectangular and symmetrical.

1.1,
D1a,
D1b
D2

1.1 DIMENSIONS

The playing court is a rectangle measuring 18 x 9 m (59' x 29'6") surrounded by a free zone which is a minimum of 3 m (9'10") wide on all sides.

The free playing space is the space above the playing area which is free from any obstructions. The free playing space shall measure a minimum of 7 m (23') in height from the playing surface.

USAV 1.1a: The free zone may be a minimum of 2 m (6'6^{3/4}). It is not required that the free zone be symmetrical.

USAV 1.1b: For nationally sanctioned competition and recommended for all other competitions, 7 m (23') is the minimum free playing space (ceiling height).

For FIVB, World and Official Competitions, the free zone shall measure a minimum of 5 m (16'5") from the side lines and 6.5 m (21'4") from the end lines. The free playing space shall measure a minimum of 12.5 m (41') in height from the playing surface.

1.2 PLAYING SURFACE

1.2.1 The surface must be flat, horizontal and uniform. It must not present any danger of injury to the players. It is forbidden to play on rough or slippery surfaces.

USAV 1.2.1: Players may mop the floor provided the 1st referee does not judge the action to be a delay.

For FIVB, World and Official Competitions, only a wooden or synthetic surface is allowed. Any surface must be previously approved by the FIVB.

USAV 1.2.1: For nationally sanctioned competition, USA Volleyball must approve the surface.

1.2.2 On indoor courts the surface of the playing court must be of a light color.

USAV 1.2.2: It is recommended the surface of the playing court be a light color or that other contrasting colors be used for the playing court and free zone.

<p>For FIVB, World and Official Competitions, white colors are required for the lines. Other colors, different from each other, are required for the playing court and the free zone.</p>	1.1, 1.3
<p>1.2.3 On outdoor courts a slope of 5 mm per meter is allowed for drainage. Court lines made of solid materials are forbidden.</p>	1.3
<p>1.3 LINES ON THE COURT</p>	D2
<p>1.3.1 All lines are 5 cm (2") wide. They must be of a light color which is different from the color of the floor and from any other lines.</p> <p><i>USAV 1.3.1: Lines are not required to be of a light color as long as they contrast with the color of the floor.</i></p>	1.2.2
<p>1.3.2 Boundary lines</p> <p>Two side lines and two end lines mark the playing court. Both side lines and end lines are drawn inside the dimensions of the playing court.</p>	1.1
<p>1.3.3 Center line</p> <p>The axis of the center line divides the playing court into two equal courts measuring 9 x 9 m (29'6" x 29'6") each; however, the entire width of the line is considered to belong to both courts equally. This line extends beneath the net from side line to side line.</p>	D2
<p>1.3.4 Attack line</p> <p>On each court, an attack line, whose rear edge is drawn 3 m (9'10") back from the axis of the center line, marks the front zone.</p>	1.3.3, 1.4.1
<p>For FIVB, World and Official Competitions, the attack line is extended by the addition of broken lines from the side lines, with five 15 cm (6") short lines 5 cm (2") wide, drawn 20 cm (8") from each other to a total length of 1.75 m (70"). The "coach's restriction line" (a broken line which extends from the attack line to the end line of the court, parallel to the side line and 1.75 meters [70"] from it) is composed of 15 cm (6") short lines drawn 20 cm (8") apart to mark the limit of the coach's area of operation.</p>	D2
<p><i>USAV 1.3.4: For nationally sanctioned competitions, the extensions of the attack lines outside the court are required as described above. These extensions are optional for all other events. The coach's restriction line is optional for all events.</i></p>	

1.4 ZONES AND AREAS

1.4.1 Front zone

On each court the front zone is limited by the axis of the center line and the rear edge of the attack line.

The front zone is considered to extend beyond the side lines to the end of the free zone.

1.4.2 Service zone

The service zone is a 9 m (29'6") wide area behind each end line.

It is laterally limited by two short lines, each 15 cm (6") long, drawn 20 cm (8") behind the end line as an extension of the side lines. Both short lines are included in the width of the service zone.

In depth, the service zone extends to the end of the free zone.

USAV 1.4.2: The service zone shall have a minimum depth of 2 m (6'6 3/4"). If this zone is fewer than 2 m (6'6 3/4") [Rule 1.4.2], a line shall be marked on the court to provide the minimum depth. After the service, the line is ignored and becomes part of the court.

1.4.3 Substitution zone

The substitution zone is limited by the extension of both attack lines up to the scorer's table.

1.4.4 Libero Replacement Zone

The Libero Replacement Zone is part of the free zone on the side of the team benches, limited by the extension of the attack line up to the end line.

1.4.5 Warm-up area

For FIVB, World and Official Competitions, the warm-up areas, sized approximately 3 x 3 m (9'10" x 9'10"), are located in both of the bench-side corners, outside the free zone.

USAV 1.4.5: The warm-up area is at the end of the bench or bench area, and no nearer to the court than the front of the team bench. Substitutes must not interfere with play or the officials' duties.

1.4.6 Penalty Area

A penalty area, sized approximately 1 x 1 m (39" x 39") and equipped with two chairs, is located in the control area, outside the prolongation of each end line. They may be limited by a 5 cm (2") wide red line.

USAV 1.4.6: Inclusion of a penalty area is recommended.

D1b, D2
19.3.1.4,
23.3.2.3e
D2
1.3.3,1.3.4
19.3.1.4,
23.3.2.3e
1.1, 1.3.2
1.3.2, 12,
D1b
1.1
1.3.4,15.6.1,
D1b
19.3.2.7,
D1b
24.2.5,
D1a,
D1b
21.3.2.1
D1a,
D1b

1.5 TEMPERATURE

The minimum temperature shall not be below 10° C (50° F).

For FIVB, World and Official Competitions, the maximum temperature shall not be higher than 25° C (77° F) and the minimum not lower than 16° C (61° F).

1.6 LIGHTING

For FIVB, World and Official Competitions, the lighting on the playing area should be 1000 to 1500 lux measured at 1 m (39") above the surface of the playing area.

USAV 1.6: For nationally sanctioned USA Volleyball competition, the lighting on the playing area should be 300 lux (27.9 foot candles) measured at 1 m (39") above the playing surface.

2 NET AND POSTS

2.1 HEIGHT OF THE NET

2.1.1 Placed vertically over the center line there is a net whose top is set at the height of 2.43 m (7'11^{5/8"}) for men and 2.24 m (7'4^{1/8"}) for women.

USAV 2.1: The height of the net may vary for specific age groups as follows:

AGE GROUPS	FEMALE/REVERSE CO-ED	MALE/CO-ED
70 years and above	2.19 m (7'2 1/8")	2.29 m (7'6")
55 years and above	2.19 m (7'2 1/8")	2.38 m (7'9 5/8")
45 years and above	2.19 m (7'2 1/8")	2.43 m (7'11 5/8")
15/18 years and under	2.24 m (7'4 1/8")	2.43 m (7'11 5/8")
13/14 years and under	2.24 m (7'4 1/8")	2.24 m (7'4 1/8")
11/12 years and under	2.13 m (7'0")	2.13 m (7'0")
10 years and under	1.98 m (6'6")	2.13 m (7'0")

2.1.2 Its height is measured from the center of the playing court. The net height (over the two side lines) must be exactly the same and must not exceed the official height by more than 2 cm (3/4").

2.2 STRUCTURE

The net is 1 m (39") wide and 9.50 to 10 meters (31'6"-33') long (with 25 to 50 cm [10"-19^{1/2"}] on each side of the side bands), made of 10 cm (4") square black mesh.

For FIVB, World and Official Competitions, in con-

junction with specific competition regulations the mesh may be modified to facilitate advertising according to marketing agreements.

At its top a horizontal band, 7 cm (2^{3/4}") wide, made of two-fold white canvas, is sewn along its full length. Each extreme end of the band has a hole, through which passes a cord, fastening the band to the posts for keeping its top taut.

USAV 2.2: At its top, a horizontal band 5 to 7 cm (2 to 2^{3/4}") wide, made of two-fold white canvas, is sewn along its full length.

Within the band, a flexible cable fastens the net to the posts and keeps its top taut.

At the bottom of the net there is another horizontal band, 5 cm (2") wide, similar to the top band, through which is threaded a rope. This rope fastens the net to the posts and keeps its lower part taut.

2.3 SIDE BANDS

Two white bands are fastened vertically to the net and placed directly above each side line.

They are 5 cm (2") wide and 1 m (39") long and are considered as part of the net.

USAV 2.3: The side bands are optional.

1.3.2,
D3

2.4 ANTENNAE

An antenna is a flexible rod, 1.80 m (5'11") long and 10 mm (3/8") in diameter, made of fiberglass or similar material.

An antenna is fastened at the outer edge of each side band. The antennae are placed on opposite sides of the net.

The top 80 cm (32") of each antenna extends above the net and is marked with 10 cm (4") stripes of contrasting color, preferably red and white.

The antennae are considered as part of the net and laterally delimit the crossing space.

2.3, D3

10.1.1,
D3, D5a,
D5b

2.5 POSTS

2.5.1 The posts supporting the net are placed at a distance of 0.50-1.00 m (20"-39") outside the side lines. They are 2.55 m (8'4") high and preferably adjustable.

For all FIVB, World and Official Competitions, the posts supporting the net are placed at a distance of 1 m (39") outside the side lines.

2.5.2 The posts are rounded and smooth, fixed to the ground without wires. There shall be no dangerous or obstructing devices.

USAV 2.5.2: Ceiling mounted net systems are allowed.

D3

2.6 ADDITIONAL EQUIPMENT

All additional equipment is determined by FIVB regulations.

USAV 2.6:

- a. *If the posts are secured by barrels or other supporting apparatus, there must be some means of clearly identifying the barrels or supporting apparatus. All other dangerous or obstructing devices must be eliminated. Metal cables, tensioning devices and other exposed wires may need to be covered if the referees determine these items may cause injury to players.*
- b. *All wires that support posts from the floor will be eliminated, or if that is not possible, then all exposed wires must be padded with at least 1.25 cm (1/2") thick, resilient, shock absorbing material throughout the entire length. The padding must be clearly recognizable.*
- c. *Posts shall be padded to a minimum height of 1.7 m (5'6") with at least 1.25 cm (1/2") thick, resilient, shock absorbing material.*
- d. *Basic equipment includes a referee stand, which should be adjustable to allow the referee's eye position to be approximately 50 cm (19") above the top of the net. It should be constructed so that it presents the least potential hazard for participants. Step ladders, jump boxes and other devices not specifically designed as referee stands shall not be used. If an appropriate referee stand cannot be provided, the 1st referee performs his/her functions from the floor.*
- e. *The front and sides of the referee's stand must be padded in the same manner as the posts to a height of 1.7 m (5'6").*
- f. *The scoreboard must be divided into two parts with numbers that provide the score for each team. The score displayed on the scoreboard is not official and may not be used as a basis of protest.*

3 BALLS

3.1 STANDARDS

The ball shall be spherical, made of a flexible leather or synthetic leather case with a bladder inside, made of rubber or a similar material.

Its color may be a uniform light color or a combination of colors. Synthetic leather material and color combinations of balls used in International Official competitions should comply with FIVB standards.

Its circumference is 65-67 cm (25.6" to 26.4") and its weight is 260-280 g (9 to 10 oz).

Its inside pressure shall be 0.30 to 0.325 kg/cm² (4.26 to 4.61 psi) (294.3 to 318.82 mbar or hPa).

USAV 3.1: Twelve-and-under competition at the USAV Junior National Championships will be conducted using a ball with the same circumference and inside pressure as listed in Rule 3.1, but with a weight of 198 to 227 g (7 to 8 oz).

3.2 UNIFORMITY OF BALLS

All balls used in a match must have the same standards regarding circumference, weight, pressure, type, color, etc.

FIVB, World and Official Competitions, as well as National or League Championships, must be played with FIVB approved balls, unless by agreement of FIVB.

USAV 3.2: For nationally sanctioned competition, USA Volleyball must approve the game balls.

3.3 FIVE-BALL SYSTEM

For FIVB, World and Official Competitions, five balls shall be used. In this case, six ball retrievers are stationed, one at each corner of the free zone and one behind each referee.

USAV 3.3: For nationally sanctioned USA Volleyball competitions, the three-ball system is recommended.

3.1

D10

CHAPTER 2 PARTICIPANTS

4 TEAMS

See
Rules

4.1 TEAM COMPOSITION

4.1.1 For the match, a team may consist of up to 12 players, plus

- Coaching Staff: one coach, **a maximum of two assistant coaches,**
- Medical Staff: one **team therapist** and one medical doctor.

Only those listed on the score sheet may normally enter the Competition/Control Area and take part in the official warm up and in the match.

For FIVB, World and Official Competitions for Seniors, up to 14 players may be recorded on the score sheet and play in a match. The maximum five staff members on the bench (including the coach) are chosen by the coach him/herself but must be listed on the score sheet and be registered on the O-2(bis).

For FIVB, World and Official Competitions, a medical doctor and team therapist should be part of the Delegation and accredited beforehand by the FIVB. However, for FIVB, World and Official Competitions for Seniors, if they are not included as members on the team bench, they must sit against the delimitation fence, inside the Competition-Control Area and may only intervene if invited by the referees to deal with an emergency to the players. The team therapist (even if not on the bench) may assist with the warm up until the start of the official net warm up session.

5.2, 5.3

D1a

7.2.1

USAV 4.1.1: a. Players are the team members on the team court. Substitutes are team members in uniform who are not in the starting line-up of a set.

b. A team may consist of a maximum of 15 players and five coaches/staff personnel (unless modified by the Specific Competition Regulations).

- 4.1.2 One of the players, other than the Libero, is the team captain, who shall be indicated on the score sheet. 5.1, 19.1.3
- 4.1.3 Only the players recorded on the score sheet may enter the court and play in the match. Once the coach and the team captain have signed the score sheet (team list for electronic score sheet), the recorded players cannot be changed. 1, 4.1.1, 5.1.1, 5.2.2

USAV 4.1.3

- a. The coach and captain do not need to sign the score sheet before the match except for the Open Division of the USA Volleyball Open National Championships.*
- b. At least 10 minutes before the start of each match, including tournament play, each team shall submit a roster listing the names and uniform numbers of players eligible to participate in the match. The coach or team captain must sign the roster. A roster may be changed at any time during the match, but only to correct a uniform number. However, if the coach or game captain requests such a number change, that team will be charged with a penalty point. A roster may not be changed to add a player at any time after having been signed by the coach or team captain.*

4.2 LOCATION OF THE TEAM

- 4.2.1 The players not in play should either sit on their team bench or be in their warm-up area. The coach and other team members sit on the bench, but may temporarily leave it. 1.4.5, 5.2.3, 7.3.3
- The benches for the teams are located beside the scorer's table, outside the free zone. D1a, D1b
- 4.2.2 Only the team composition members are permitted to sit on the bench during the match and to participate in the official warm-up session. 4.1.1, 7.2
- 4.2.3 Players not in play may warm up without balls as follows:
- 4.2.3.1 during play: in the warm-up areas; 1.4.5, 8.1, D1a, D1b
- 4.2.3.2 during time-outs and technical time-outs: 1.3.3, 15.4
- in the free zone behind their court.
- 4.2.4 During set intervals, players may warm up using balls **within their own free zone. During the extended interval between sets 2 and 3 (if used), players may use their own court as well.** 18.1

USAV 4.2.4: During set intervals, players may warm up using balls on their court or in the free zone.

4.3 EQUIPMENT

A player's equipment consists of a jersey, shorts, socks (the uniform) and sport shoes.

USAV 4.3: If undergarments, including but not limited to T-shirts, boxer shorts, tights, leotards, body suits, bicycle shorts, sports bras, etc., are worn in such a manner that they are exposed, they will be considered a part of the uniform. In that case, they must be similar and the same color for any team members (except the Libero) who wear such a uniform. Socks and sport shoes are not part of the uniform.

4.3.1 The color and the design for the jerseys, shorts and socks must be uniform for the team (except for the Libero). The uniforms must be clean. 4.1, 19.2

USAV 4.3.1: The color and design for the jerseys and shorts must be uniform for the team (except for the Libero).

4.3.2 The shoes must be light and pliable with rubber or composite soles without heels.

4.3.3 Players' jerseys must be numbered from 1 to 20. 4.3.3.2

USAV 4.3.3: The players' jerseys must be numbered in a permanent manner from 1 to 99 using Arabic numerals. Duplicate numbers are not allowed.

4.3.3.1 The number must be placed on the jersey at the center of the front and of the back. The color and brightness of the numbers must contrast with the color and brightness of the jerseys.

USAV 4.3.3.1

- a. Uniform numbers must be clearly visible and centered (both horizontally and vertically) on the player's chest and upper back.*
- b. Each jersey must use the same color and number height for all players, except the Libero's jersey, which may have different color and size numbers, provided it still meets the minimum criteria stated in USAV 4.3.3.2.*
- c. Color combinations such as purple/black, dark green/black, navy/black, white/light yellow or navy/maroon are not distinctive enough to comply with the rules.*

4.3.3.2 The number must be a minimum of 15 cm (6") in height on the chest, and a minimum of 20 cm

(8") in height on the back. The stripe forming the numbers shall be a minimum of 2 cm (3/4") in width.

USAV 4.3.3.2: The numbers must be a minimum of 10 cm (4") in height on the chest and a minimum of 15 cm (6") in height on the back. It is recommended that the numbers be a minimum of 15 cm (6") in height on the chest and a minimum of 20 cm (8") on the back.

- 4.3.4 The team captain must have on his/her jersey a stripe of 8 x 2 cm (3.15" x 8/10") underlining the number on the chest. 5.1

USAV 4.3.4: It is recommended that the captain have a stripe on his/her jersey underlining the number on the chest.

- 4.3.5 It is forbidden to wear uniforms of a color different from that of the other players (except for the Liberos), and/or without official numbers. 19.2

USAV 4.3.5: For nationally sanctioned competition, uniforms must be identical with the exception of sleeve length and the Libero players. An exception will also be made for a single manufacturer's logo or trademark on the outside of the jerseys or shorts, provided that the logo or trademark does not exceed 14.6 square cm (2 1/4 square inches).

4.4 CHANGE OF EQUIPMENT

- The 1st referee may authorize one or more players: 23

4.4.1 to play barefoot;

4.4.2 to change wet or damaged uniforms between sets or after substitution, provided that the color, design and number of the new uniform(s) are the same, 4.3, 15.5

4.4.3 to play in training suits in cold weather, provided that they are of the same color and design for the whole team (except for the Liberos) and numbered according to Rule 4.3.3. 4.1.1, 19.2

4.5 FORBIDDEN OBJECTS

- 4.5.1 It is forbidden to wear objects which may cause injury or give an artificial advantage to the player.

USAV 4.5.1: It is forbidden to wear hats or casts (even if padded). Braces, jewelry, prosthetic limbs or other headgear that may cause an injury or give an

artificial advantage to the player must not be worn. If a brace, prosthetic limb or headgear is used, padding or covering may be necessary. A junior volleyball athlete participating in a junior event may not wear jewelry. An exception will be made for religious or medical medals that are removed from chains and taped or sewn under the uniform.

4.5.2 Players may wear glasses or lenses at their own risk.

USAV 4.5.2: If a player's equipment falls to the floor and creates a safety hazard, play is stopped and a delay sanction assessed.

4.5.3 Compression pads (padded injury protection devices) may be worn for protection or support.

For FIVB, World and Official Competitions for Seniors, these devices must be of the same color as the corresponding part of the uniform.

5 TEAM LEADERS

Both the team captain and the coach are responsible for the conduct and discipline of their team members. 20

The Liberos cannot be either the team or game captain.

USAV 5: The Libero CAN be team captain, game captain or both.

5.1 CAPTAIN

5.1.1 PRIOR TO THE MATCH, the team captain signs the score sheet and represents his/her team in the toss. 7.1, 25.2.1.1

USAV 5.1.1: The captain does not sign the score sheet before the match.

5.1.2 DURING THE MATCH and while on the court, the team captain is the game captain. When the team captain is not on the court, the coach or the team captain must assign another player on the court, but not the Libero, to assume the role of game captain. This game captain maintains his/her responsibilities until he/she is substituted, or the team captain returns to play, or the set ends. 15.2.1

When the ball is out of play, only the game captain is authorized to speak to the referees: 8.2

USAV 5.1.2: When the team captain is not on the court the coach or the team captain must assign another player on the court to assume the role of game captain.

5.1.2.1 to ask for an explanation on the application or interpretation of the Rules, and also to submit the requests or questions of his/her team- 23.2.4

mates. If the game captain does not agree with the explanation of the 1st referee, he/she may choose to protest against such decision and immediately indicates to the 1st referee that he/she reserves the right to record an official protest on the score sheet at the end of the match;

USAV 5.1.2.1: If an explanation of an application or interpretation of a rule is not satisfactory to the game captain, he/she must immediately indicate his/her disagreement and file an official protest prior to the authorization of the next service. If the disagreement with the referees' explanation involves the last point of the set, the official protest must be recorded within the first 60 seconds of the timed interval between sets. If the final point of the match is disputed, the protest must be recorded within the first 60 seconds after the final point of the match is scored. (Protest is ruled upon by the Championship Committee either immediately or prior to the start of the next set.) It is advisable to have an assigned Protest Committee available to rule upon a protest as soon as possible prior to the first service following the protest. Such action should preclude playing the match over from the point of protest if the protest is upheld. Protests considered by the 1st referee (Protest or Tournament Committee) include: a 1) misinterpretation of a playing rule, 2) failure of the 1st referee to apply the correct rule to a given situation, or 3) failure to charge the correct penalty-sanction for a given fault. Protest facts recorded on the score sheet include the: 1) score of the set at the time of the protest, 2) players and positions at the time of the protest, 3) player substitutions and team substitutions made up to the protest, 4) team time-outs taken up to the protest, 5) situation that caused the protest, and 6) signatures of the scorer, captains and 1st referee, indicating the facts are correct.

5.1.2.2 to ask authorization:

- a) to change all or part of the equipment;
- b) to verify the positions of the teams;

4.3, 4.4.2,
7.4, 7.6,

	c) to check the floor, the net, the ball, etc.;	1.2, 2, 3
	<i>USAV 5.1.2.2: For nationally sanctioned 14-and-under competition, the coach may act instead of the game captain to perform the functions stated in 5.1.2.1 and 5.1.2.2.</i>	
5.1.2.3	in the absence of the coach to request time-outs and substitutions.	15.3.1, 15.4.1, 15.5.2
	<i>USAV 5.1.2.3: The captain may request a time-out.</i>	
5.1.3	AT THE END OF THE MATCH, the team captain:	6.3
5.1.3.1	thanks the referees and signs the score sheet to ratify the result;	25.2.3.3
5.1.3.2	may, when it has been notified in due time to the 1 st referee, confirm and record on the score sheet an official protest regarding the referee's application or interpretation of the rules.	5.1.2.1, 25.2.3.2
	<i>USAV 5.1.3: The captain does not sign the score sheet after the match. It is no longer required that either coach sign the score sheet after the match to verify the results.</i>	
5.2 COACH		
5.2.1	Throughout the match, the coach conducts the play of his/her team from outside the playing court. He/she selects the starting line-ups, the substitutes, and takes time-outs. In these functions his/her contacting official is the 2 nd referee.	1.1, 7.3.2, 15.4.1, 15.5.2
5.2.2	PRIOR TO THE MATCH, the coach records or checks the names and numbers of his/her players on the score sheet, and then signs it.	4.1, 19.1.3, 25.2.1.1
	<i>USAV 5.2.2: The coach does not sign the score sheet before the match.</i>	
5.2.3	DURING THE MATCH, the coach:	
5.2.3.1	prior to each set, gives the 2 nd referee or the scorer the line-up sheet(s) duly filled in and signed;	7.3.2, 7.4, 7.6
5.2.3.2	sits on the team bench nearest to the scorer, but may leave it;	4.2
5.2.3.3	requests time-outs and substitutions;	15.4, 15.5,
	<i>USAV 5.2.3: During the match the coach is authorized to speak to the referees to verify the positions of the teams.</i>	
5.2.3.4	may, as well as other team members, give instructions to the players on the court. The coach may give these instructions while stand-	1.3.4, 1.4.5, D1a,

ing or walking within the free zone in front of his/her team's bench from the extension of the attack line up to the warm-up area, without disturbing or delaying the match.

D1b,
D2

For FIVB, World and Official Competitions, the coach is restricted to performing his/her function behind the coach's restriction line.

D1a,
D1b,
D2

USAV 5.2.3.4: During play, the coach may give these instructions while standing or walking within the free zone in front of his/her team's bench from the extension of the attack line up to the warm-up area, no closer to the court than 1.75 m (5'10") from the sideline and its extension without disturbing or delaying the match. The extension of the attack line is drawn to a distance of 1.75 m (5'10") from the sideline.

5.3 ASSISTANT COACH

- 5.3.1 The assistant coach sits on the team bench, but has no right to intervene in the match.

USAV 5.3.1: One assistant coach at a time may stand to give instructions to the players on the court, but has no right to intervene in the match. During play, this assistant coach may give these instructions while standing or walking within the free zone in front of his/her team's bench from the extension of the attack line up to the warm-up area, and no closer to the court than 1.75 m (5'10") from the sideline and its extension, without disturbing or delaying the match. The extension of the attack line is drawn to a distance of 1.75 m (5'10") from the sideline.

- 5.3.2 Should the coach have to leave his/her team for any reason including sanction, but excluding entering the court as a player, an assistant coach may assume the coach's functions for the duration of the absence, once confirmed to the referee by the game captain.

5.1.2,
5.2

CHAPTER 3 PLAYING FORMAT

6 TO SCORE A POINT, TO WIN A SET AND THE MATCH	See Rules
6.1 TO SCORE A POINT	
6.1.1 Point	
A team scores a point:	
6.1.1.1 by successfully grounding the ball on the opponent's court;	8.3, 10.1.1
6.1.1.2 when the opponent team commits a fault;	6.1.2
6.1.1.3 when the opponent team receives a penalty.	16.2.3, 21.3.1
6.1.2 Fault	
A team commits a fault by making a playing action contrary to the rules (or by violating them in some other way). The referees judge the faults and determine the consequences according to the Rules:	
6.1.2.1 If two or more faults are committed successively, only the first one is counted.	
6.1.2.2 If two or more faults are committed by opponents simultaneously, a DOUBLE FAULT is called and the rally is replayed.	6.1.2, D11(23)
6.1.3 Rally and completed rally	
A rally is the sequence of playing actions from the moment of the service hit by the server until the ball is out of play. A completed rally is the sequence of playing actions, which results in the award of a point. <u>This includes the award of a penalty point and loss of service for failing to serve within the time limit.</u>	8.1, 8.2, 12.2.2.1, 12.4.4, 15.2.3, 15.11.1.3, 19.3.2.1, 19.3.2.9, 21.3.1
6.1.3.1 If the serving team wins a rally, it scores a point and continues to serve.	
6.1.3.2 If the receiving team wins a rally, it scores a point and it must serve next.	
6.2 TO WIN A SET	D11 (9)
A set (except the deciding 5th set) is won by the team which first scores 25 points with a minimum lead of two points. In the case of a 24-24 tie, play is continued until a two-point lead is achieved (26-24; 27-25; ...).	6.3.2

6.3 TO WIN THE MATCH

- 6.3.1 The match is won by the team that wins three sets.
- 6.3.2 In the case of a 2-2 tie, the deciding 5th set is played to 15 points with a minimum lead of 2 points.

USAV 6.3:

- a. *For tournament play, the match is won by the team that wins two sets out of three. A set (except the deciding third set) is won by the first team to score 25 points with a minimum lead of two points.*
- b. *A playoff set is considered a match and only one set will be played. The match is won by the team that scores either 15 or 25 (as specified in the tournament guidelines) with a two-point advantage. Teams change courts when one team has scored eight or 13 points, respectively.*

D11 (9)

6.2

7.1

6.4 DEFAULT AND INCOMPLETE TEAM

- 6.4.1 If a team refuses to play after being summoned to do so, it is declared in default and forfeits the match with the result 0-3 for the match and 0-25 for each set. 6.2, 6.3
- 6.4.2 A team that, without justifiable reason, does not appear on the playing court on time is declared in default with the same result as in Rule 6.4.1.
- 6.4.3 A team that is declared INCOMPLETE for the set or for the match, loses the set or the match. The opponent team is given the points, or the points and the sets, needed to win the set or the match. The incomplete team keeps its points and sets. 6.2, 6.3, 7.3.1

USAV 6.4: Matches that are two sets out of three would have a default match score of 0-2.

7 STRUCTURE OF PLAY

7.1 THE TOSS

Before the match, the 1st referee carries out a toss to decide upon the first service and the sides of the court in the first set. 12.1.1

If a deciding set is to be played, a new toss will be carried out. 6.3.2

7.1.1 The toss is taken in the presence of the two team captains. 5.1

7.1.2 The winner of the toss chooses:

EITHER

7.1.2.1 the right to serve or to receive the service, 12.1.1

OR

7.1.2.2 the side of the court.

The loser takes the remaining choice.

7.2 OFFICIAL WARM-UP SESSION

7.2.1 Prior to the match, if the teams have previously had a playing court exclusively at their disposal, they are entitled to a 6-minute official warm-up period together at the net; if not, they may have 10 minutes.

For FIVB, World and Official competitions, teams will be entitled to a 10-minute warm up period together at the net.

7.2.2 If either captain requests separate (consecutive) official warm-ups at the net, the teams are allowed 3 minutes each or 5 minutes each.

7.2.1

USAV 7.2.2

a. For adult competition, it is recommended that teams warm up together at the net for 10 minutes if both team captains agree; otherwise, each team will have five minutes separately. For consecutive warm-up periods, the team with first service has the court first.

b. For junior competition, when one team has exclusive use of the court, the other team must either be at its team bench or out of the playing area. Warm-up with balls at the team bench or in the spectator walkways is not permitted.

7.2.3 In the case of consecutive official warm-ups, the team that has the first service takes the first turn at the net.

7.1.2.1,
7.2.2

7.3 TEAM STARTING LINE-UP

7.3.1 There must always be six players per team in play. The team's starting line-up indicates the rotational order of the players on the court. This order must be maintained throughout the set.

6.4.3
7.6

USAV 7.3.1: If failure to adhere to Rule 7.3.1 is due to insufficient players on a team to begin a match, the team defaults the first set at match time. After a team defaults the first set of a match, an interval of up to 10 minutes shall be allowed for the team to produce sufficient players to play the next set. If the team has six players present prior to the expiration of this interval, play shall begin immediately. If, after the 10-minute interval a team does not have at least six players present and ready to play, the second set shall be declared a default. If the match consists of the best three out of five sets, an additional 10-minute interval shall be allowed before declaring the match a default.

7.3.2	Before the start of each set, the coach has to present the starting line-up of his/her team on a line-up sheet. The sheet is submitted, duly filled in and signed, to the 2 nd referee or the scorer.	5.2.3.1, 24.3.1, 25.2.1.2
<i>USAV 7.3.2: At least two minutes before the end of the timed warm-up period and 30 seconds prior to the expiration of the interval between sets, a coach or game captain submits the team's starting line-up on a signed line-up sheet to the 2nd referee or scorer.</i>		
7.3.3	The players who are not in the starting line-up of a set are the substitutes for that set (except the Liberos).	7.3.2, 15.5
7.3.4	Once the line-up sheet has been delivered to the 2nd referee or scorer, no change in line-up may be authorized without a regular substitution.	15.2.2, 15.5, D11 (5)
7.3.5	Discrepancies between players' position on court and on the line-up sheet are dealt with as follows:	24.3.1
7.3.5.1	When such a discrepancy is discovered before the start of the set, players' positions must be rectified according to those on the line-up sheet—there will be no sanction;	7.3.2
7.3.5.2	when, before the start of the set, any player on court is found not to be registered on the line-up sheet of that set, this player must be changed to conform to the line-up sheet—there will be no sanction;	7.3.2
7.3.5.3	however, if the coach wishes to keep such non-recorded player(s) on the court, he/she has to request regular substitution(s), by use of the corresponding hand signal, which will then be recorded on the score sheet. If a discrepancy between players' positions and the line-up sheet is discovered later, the team at fault must revert to the correct positions. The opponent's points remain valid and in addition they receive a point and the next service. All points scored by the team at fault from the exact moment of the fault up to the discovery of the fault are cancelled.	15.2.2, D11 (5)
7.3.5.4	Where a player is found to be on court but he/she is not registered on the score sheet list of players, the opponent's points remain valid, and in addition they gain a point and service. The team at fault will lose all points and/or sets (0:25, if necessary) gained from	6.1.2, 7.3.2

the moment the non-registered player entered the court, and will have to submit a revised line-up sheet and send a new registered player into the court, in the position of the non-registered player.

7.4 POSITIONS

At the moment the ball is hit by the server, each team must be positioned within its own court in the rotational order (except the server).

7.4.1 The positions of the players are numbered as follows:

7.4.1.1 The three players along the net are front-row players and occupy positions 4 (front-left), 3 (front-center) and 2 (front-right);

7.4.1.2 The other three are back-row players occupying positions 5 (back-left), 6 (back-center) and 1 (back-right).

7.4.2 Relative positions between players:

7.4.2.1 Each back-row player must be positioned further back from the center line than the corresponding front-row player;

7.4.2.2 The front-row players and the back-row players, respectively, must be positioned laterally in the order indicated in Rule 7.4.1.

7.4.3 The positions of players are determined and controlled according to the positions of their feet contacting the ground as follows:

7.4.3.1 each front-row player must have at least a part of his/her foot closer to the center line than the feet of the corresponding back-row player;

7.4.3.2 each right- (left-) side player must have at least a part of his/her foot closer to the right (left) side line than the feet of the center player in that row.

USA V 7.4.3: The position of the players is judged according to the position of the foot last in contact with the floor at the time the ball is contacted for service.

7.4.4 After the service hit, the players may move around and occupy any position on their court and the free zone.

D4

7.6.1,
8.1,
12.4

D4

1.3.3

1.3.2

7.5 POSITIONAL FAULT

- | | |
|--|----------------------|
| | D4,
D11 (13) |
| 7.5.1 The team commits a positional fault, if any player is not in his/her correct position at the moment the ball is hit by the server. This includes when a player is on court through illegal substitution. | 7.3,
7.4,
15.9 |
| 7.5.2 If the server commits a serving fault at the moment of the service hit, the server's fault is counted before a positional fault. | 12.4,
12.7.1 |
| 7.5.3 If the service becomes faulty after the service hit, it is the positional fault that will be counted. | 12.7.2 |
| 7.5.4 A positional fault leads to the following consequences: | |
| 7.5.4.1 the team is sanctioned with a point and service to the opponent; | 6.1.3 |
| 7.5.4.2 players' positions must be rectified. | 7.3, 7.4 |

7.6 ROTATION

- | | |
|---|--------------------------|
| 7.6.1 The rotational order is determined by the team's starting line-up and controlled with the service order and players' positions throughout the set. | 7.3.1,
7.4.1,
12.2 |
| 7.6.2 When the receiving team has gained the right to serve, its players rotate one position clockwise: the player in position 2 rotates to position 1 to serve, the player in position 1 rotates to position 6, etc. | 12.2.2.2 |

7.7 ROTATIONAL FAULT

- | | |
|--|-------------------|
| | D11(13) |
| 7.7.1 A rotational fault is committed when the SERVICE is not made according to the rotational order. It leads to the following consequences <u>in order</u> : | 7.6.1,
12 |
| <i>USAV 7.7.1: A rotational fault is committed when a Libero serves in a second rotation position in the same set.</i> | |
| 7.7.1.1 the team is sanctioned with a point and service to the opponent; | 6.1.3 |
| 7.7.1.2 the players' rotational order must be rectified. | 7.6.1 |
| 7.7.2 Additionally, the scorer should determine the exact moment when the fault was committed, and all points scored subsequently by the team at fault must be cancelled. The opponent's points remain valid. If that moment cannot be determined, no point(s) cancellation takes place, and a point and service to the opponent is the only sanction. | 25.2.2.2
6.1.3 |

CHAPTER 4 PLAYING ACTIONS

8 STATES OF PLAY

See
Rules

8.1 BALL IN PLAY

The ball is in play from the moment of the hit of the service authorized by the 1st referee.

12, 12.3

8.2 BALL OUT OF PLAY

The ball is out of play at the moment of the fault which is whistled by one of the referees; in the absence of a fault, at the moment of the whistle.

USAV 8.2: In the case of an inadvertent whistle, the rally is ended. The 1st referee must make a ruling that will not penalize either team.

8.3 BALL “IN”

The ball is “in” if at any moment of its contact with the floor, some part of the ball touches the court, including the boundary lines.

D11 (14)
D12 (1)

1.1,
1.3.2

8.4 BALL “OUT”

The ball is “out” when:

8.4.1 the part of the ball which contacts the floor is completely outside the boundary lines;

1.3.2,
D11(15),
D12(2)

8.4.2 it touches an object outside the court, the ceiling or a person out of play;

D11(15),
D12(4)

USAV 8.4.2: A ball, other than a served ball, shall remain in play if it contacts the ceiling or other overhead objects 4.6 m (15') or more above the playing area.

a. If benches, bleachers, low-hanging baskets or other floor obstructions are fewer than 2 m (6'6^{3/4}") from the court and interfere with play of the ball, the ball becomes out of play and a playover may be directed at the 1st referee's discretion.

b. The ball is out of play when:

i. Rule 10.1.2 is not in effect, and the ball makes contact with the ceiling or obstruction above the opponent's playing area.

ii. Rule 10.1.2 is in effect, and a ball that cannot be legally retrieved from the opponent's free zone contacts the ceiling or obstruction over the opponent's playing area.

- iii. *The ball contacts the ceiling or obstruction above the team's playing area and crosses the plane of the net into the opponent's court.*
- c. *A ball, other than a served ball, is out of play and a playover directed if it contacts overhead object(s) or the supports (e.g., basketball backboard) fewer than 4.6 m (15') above the playing area and would have remained playable if the object had not been present.*
- d. *A ball is out of play if it contacts the ceiling or overhead objects, regardless of height, over non-playing areas.*
- e. *A ball is out of play and a playover is directed if the ball comes to rest on an overhead object above the team's playing area and is still a playable ball.*
- f. *If an official, media equipment or personnel or spectator interferes with a player's legal attempt to play the ball over the playing area, a playover shall be directed.*

- 8.4.3 it touches the antennae, ropes, posts or the net itself outside the side bands; 23, D3, D5a, D11(15), D12(4)
- 8.4.4 it crosses the vertical plane of the net either partially or totally outside the crossing space, except in the case of Rule 10.1.2; 23, D5a, D5b, D11(15), D12(4)
- 8.4.5 it crosses completely the lower space under the net. 23.3.2.3f, D5a, D11(22)

9 PLAYING THE BALL

Each team must play within its own playing area and space (except Rule 10.1.2). The ball may, however, be retrieved from beyond the free zone.

USAV 9: The ball may be retrieved from beyond the free zone when the surface change is 1.25 cm (1/2") or less, the secondary surface is lower than the free zone and the area is free of obstructions.

If obstructions or other safety concerns prohibit retrieval from beyond the free zone, the player retrieving a ball over a non-playing area must be in contact with the playing surface when contact with the ball is made.

Non-playing areas are defined as the: (1) walls, bleachers or other spectator seating areas; (2) team benches and any area behind the team benches; (3) area between the scorer's

table and the team benches; (4) any other area outlined in the pre-match conference by the 1st referee. [Rule 23.2.5]

- a. If nets or dividers are separating courts, only the player attempting to play the ball may move the net or divider to play the ball.
- b. When competition is scheduled or is occurring on adjacent court(s), it is a fault for a player to enter the adjacent court(s) to play a ball or after playing a ball. The free zone, including the service zone on an adjacent court, is a playing area.

9.1 TEAM HITS

A hit is any contact with the ball by a player in play.

The team is entitled to a maximum of three hits (in addition to blocking), for returning the ball. If more are used, the team commits the fault of “FOUR HITS.”

14.4.1

9.1.1 CONSECUTIVE CONTACTS

A player may not hit the ball two times consecutively (except Rules 9.2.3, 14.2 and 14.4.2).

9.2.3,
14.2,
14.4.2

9.1.2 SIMULTANEOUS CONTACTS

Two or three players may touch the ball at the same moment.

9.1.2.1 When two (or three) teammates touch the ball simultaneously, it is counted as two (or three) hits (with the exception of blocking). If they reach for the ball, but only one of them touches it, one hit is counted. A collision of players does not constitute a fault.

USAV 9.1.2.1: When two or more teammates touch the ball simultaneously, it is counted as one hit. Any player may play the ball next if the simultaneous hit is not the third team hit. If teammates collide, no fault is committed.

9.1.2.2 When two opponents touch the ball simultaneously over the net and the ball remains in play, the team receiving the ball is entitled to another three hits. If such a ball goes “out,” it is the fault of the team on the opposite side.

9.1.2.3 If simultaneous hits by two opponents over the net lead to an extended contact with the ball, play continues.

9.1.2.2

9.1.3 ASSISTED HIT

Within the playing area, a player is not permitted to take support from a teammate or any structure/object

1

in order to hit the ball.
 However, a player who is about to commit a fault (touch the net or cross the center line, etc.) may be stopped or held back by a teammate. 1.3.3, 11.4.4

9.2 CHARACTERISTICS OF THE HIT

- 9.2.1 The ball may touch any part of the body.
- 9.2.2 The ball must not be caught and/or thrown. It can rebound in any direction. 9.3.3
- 9.2.3 The ball may touch various parts of the body, provided that the contacts take place simultaneously.

Exceptions:

- 9.2.3.1 at blocking, consecutive contacts may be made by one or more player(s), provided that the contacts occur during one action; 14.1.1, 14.2
- 9.2.3.2 at the first hit of the team, the ball may contact various parts of the body consecutively, provided that the contacts occur during one action. 9.1, 14.4.1

9.3 FAULTS IN PLAYING THE BALL

- 9.3.1 FOUR HITS: a team hits the ball four times before returning it. 9.1, D11(18)
- 9.3.2 ASSISTED HIT: a player takes support from a teammate or any structure/object in order to hit the ball within the playing area. 9.1.3
- 9.3.3 CATCH: the ball is caught and/or thrown; it does not rebound from the hit. 9.2.2, D11(16)
- 9.3.4 DOUBLE CONTACT: a player hits the ball twice in succession or the ball contacts various parts of his/her body in succession. 9.2.3, D11(17)

10 BALL AT THE NET

10.1 BALL CROSSING THE NET

- 10.1.1 The ball sent to the opponent’s court must go over the net within the crossing space. The crossing space is the part of the vertical plane of the net limited as follows: 2.4, 10.2, D5a
 - 10.1.1.1 below, by the top of the net; 2.2
 - 10.1.1.2 at the sides, by the antennae, and their imaginary extension; 2.4
 - 10.1.1.3 above, by the ceiling.
- 10.1.2 The ball that has crossed the net plane to the 9.1 D5b

opponent's free zone totally or partly through the external space, may be played back within the team hits, provided that:

USAV 10.1.2: A minimum of 2 m (6'6 ^{3/4}") clearance beyond the court equipment on both sides is required.

- | | | |
|----------|--|-------------------------|
| 10.1.2.1 | the opponent's court is not touched by the player; | 11.2.2 |
| 10.1.2.2 | the ball, when played back, crosses the net plane again totally or partly through the external space on the same side of the court. The opponent team may not prevent such action. | 11.4.4, D5b |
| 10.1.3 | The ball that is heading toward the opponent's court through the lower space is in play until the moment it has completely crossed the vertical plane of the net. | 23.3.2.3f, D5a, D11(22) |

10.2 BALL TOUCHING THE NET

While crossing the net, the ball may touch it. 10.1.1

10.3 BALL IN THE NET

- | | | |
|--------|---|-----|
| 10.3.1 | A ball driven into the net may be recovered within the limits of the three team hits. | 9.1 |
| 10.3.2 | If the ball rips the mesh of the net or tears it down, the rally is cancelled and replayed. | |

11 PLAYER AT THE NET

11.1 REACHING BEYOND THE NET

- | | | |
|--------|---|------------|
| 11.1.1 | In blocking, a player may touch the ball beyond the net, provided that he/she does not interfere with the opponent's play before or during the latter's attack hit. | 14.1, 14.3 |
| 11.1.2 | After an attack hit, a player is permitted to pass his/her hand beyond the net, provided that the contact has been made within his/her own playing space. | |

11.2 PENETRATION UNDER THE NET

- | | | |
|--------|---|--------------------------|
| 11.2.1 | It is permitted to penetrate into the opponent's space under the net, provided that this does not interfere with the opponent's play. | |
| 11.2.2 | Penetration into the opponent's court, beyond the center line: | 1.3.3, 11.2.2.1, D11(22) |

- 11.2.2.1 to touch the opponent's court with a foot (feet) is permitted, provided that some part of the penetrating foot (feet) remains either in contact with or directly above the center line; 1.3.3, 11.2.2.1, D11(22)
- 11.2.2.2 to touch the opponent's court with any part of the body above the feet is permitted provided that it does not interfere with the opponent's play.

USAV 11.2.2: Encroachment into the opponent's court with any part(s) of the body is permitted, provided some part of the body remains either in contact with or directly above the center line, and there is no interference with opponents.

In addition, completely crossing the center line with the foot, feet, or hands, or encroachment with other body parts, must not present a safety hazard to opponents.

- 11.2.3 A player may enter the opponent's court after the ball goes out of play. 8.2
- 11.2.4 Players may penetrate into the opponent's free zone provided that they do not interfere with the opponent's play.

11.3 CONTACT WITH THE NET

- 11.3.1 **Contact with the net by a player between the antennae, during the action of playing the ball, is a fault. The action of playing the ball includes (among others) take-off, hit (or attempt) and landing.** 11.4.4, 23.2.2.3c, 24.3.2.3, D3
- 11.3.2 Players may touch the post, ropes, or any other object outside the antennae, including the net itself, provided that it does not interfere with play. D3
- 11.3.3 When the ball is driven into the net, causing it to touch an opponent, no fault is committed.

11.4 PLAYER'S FAULTS AT THE NET

- 11.4.1 A player touches the ball or an opponent in the opponent's space before or during the opponent's attack hit. 11.1.1, D11(20)
 - 11.4.2 A player interferes with the opponent's play while penetrating into the opponent's space under the net. 11.2.1
 - 11.4.3 A player's foot (feet) penetrates completely into the opponent's court. 11.2.2.2, D11(22)
- USAV 11.4.3: Regarding penetration by a player's foot (feet), see USAV 11.2.2.*
- 11.4.4 A player interferes with play by (amongst others):

- touching the net between the antennae or the antenna itself during his/her action of playing the ball, 11.3.1
 - using the net between the antennae as a support or stabilizing aid. D11(19)
 - creating an unfair advantage over the opponent by touching the net,
 - making actions which hinder an opponent's legitimate attempt to play the ball, or
 - catching/holding onto the net.
- Players close to the ball as it is played, or who are trying to play it, are considered in the action of playing the ball, even if no contact is made with the ball. However, touching the net outside the antenna is not to be considered a fault (except for Rule 9.1.3).

12 SERVICE

The service is the act of putting the ball into play, by the back-right player, placed in the service zone. 1.4.2, 8.1, 12.4.1

12.1 FIRST SERVICE IN A SET

- 12.1.1 The first service of the first set, as well as that of the deciding 5th set, is executed by the team determined by the toss. 6.3.2, 7.1
- 12.1.2 The other sets will be started with the service of the team that did not serve first in the previous set.

12.2 SERVICE ORDER

- 12.2.1 The players must follow the service order recorded on the line-up sheet. 7.3.1, 7.3.2
- 12.2.2 After the first service in a set, the player to serve is determined as follows: 12.1
 - 12.2.2.1 when the serving team wins the rally, the player (or his/her substitute) who served before, serves again; 6.1.3, 15.5
 - 12.2.2.2 when the receiving team wins the rally, it gains the right to serve and rotates before actually serving. The player who moves from the front-right position to the back-right position will serve. 6.1.3, 7.6.2

12.3 AUTHORIZATION OF THE SERVICE

The 1st referee authorizes the service, after having checked that the two teams are ready to play and that the server is in possession of the ball. 12, D11(1)

USAV 12.3: The server shall be on the playing surface to receive authorization for service.

12.4 EXECUTION OF THE SERVICE

12.4.1 The ball shall be hit with one hand or any part of the arm after being tossed or released from the hand(s).

12.4.2 Only one toss or release of the ball is allowed. Dribbling or moving the ball in the hands is permitted.

12.4.3 At the moment of the service hit or take-off for a jump service, the server must not touch the court (the end line included) or the floor outside the service zone.

After the hit, he/she may step or land outside the service zone, or inside the court.

USAV 12.4.3: The entire service action must take place on the playing area.

12.4.4 The server must hit the ball within 8 seconds after the 1st referee whistles for service.

USAV 12.4.4: For 14-and-under age groups:

a. The server must contact the ball within 5 seconds after the 1st referee whistles for service.

b. If the ball, after having been tossed or released by the server, lands without touching the player, it is considered a service tossing error.

c. After a service tossing error, the referee must authorize the service again (re-serve) and the server must execute it within the next 5 seconds.

d. One service tossing error is permitted for each service.

12.4.5 A service executed before the referee's whistle is cancelled and repeated.

USAV 12.4.5: After the whistle for the service, no other actions (requests for line-up check, time-out, substitution, etc.) may be considered until after the ball has been served and the rally completed. This is true even if a request has been made after a server has initiated service action and legally permitted the ball to fall to the floor. A re-serve is considered to be part of a single effort to serve and must be completed before any requests may be considered.

D11(10)

1.4.2,
27.2.1.4,
D11(22),
D12(4)

12.3,
D11(11)

12.3

12.5 SCREENING

- 12.5.1 The players of the serving team must not prevent their opponent, through individual or collective screening, from seeing the server and the flight path of the ball. D6,
D11(12)
12.5.2
- 12.5.2 A player or group of players of the serving team make(s) a screen by waving arms, jumping or moving sideways, during the execution of the service, or by standing grouped to hide the server and the flight path of the ball. 12.4, D6

USAV 12.5.2: The factors to be weighed when judging whether a screen has been committed are the: (a) relative positions of the players on the serving team; (b) path of the serve; (c) speed of the serve; and (d) trajectory of the serve. If the players of the serving team are positioned close to each other, the serve passes over these players, is fast and has a low trajectory, the probability is greater that a screen has been committed. The probability that a screen has been committed is lower if the: (a) players of the serving team are not positioned close to each other or are attempting to prevent the commission of a screen (i.e., bending over); (b) path of the serve is not over the players; (c) speed of the serve is slow; or (d) trajectory of the serve is high.

12.6 FAULTS MADE DURING THE SERVICE

- 12.6.1 Serving faults.
 - The following faults lead to a change of service even if the opponent is out of position. The server: 12.2.2.2,
12.7.1
 - 12.6.1.1 violates the service order; 12.2
 - 12.6.1.2 does not execute the service properly. 12.4

USAV 12.6.1.2: It is a serving fault if the service toss touches any obstruction before the service contact.
- 12.6.2 Faults after the service hit.
 - After the ball has been correctly hit, the service becomes a fault (unless a player is out of position) if the ball: 12.4,
12.7.2
 - 12.6.2.1 touches a player of the serving team or fails to cross the vertical plane of the net completely through the crossing space; 8.4.4,
8.4.5,
10.1.1,
D11(19)

- | | | |
|----------|-----------------------|------------------|
| 12.6.2.2 | goes “out”; | 8.4,
D11(15) |
| 12.6.2.3 | passes over a screen. | 12.5,
D11(12) |

USAV 12.6.2: After the ball has been correctly hit, the service becomes a fault if the ball touches any overhead obstruction.

12.7 SERVING FAULTS AND POSITIONAL FAULTS

- | | | |
|--------|--|----------------------------|
| 12.7.1 | If the server makes a fault at the moment of the service hit (improper execution, wrong rotational order, etc.) and the opponent is out of position, it is the serving fault which is sanctioned. | 7.5.1,
7.5.2,
12.6.1 |
| 12.7.2 | Instead, if the execution of the service has been correct, but the service subsequently becomes faulty (goes out, goes over a screen, etc.), the positional fault has taken place first and is sanctioned. | 7.5.3,
12.6.2 |

13 ATTACK HIT

13.1 CHARACTERISTICS OF THE ATTACK HIT

- | | | |
|--------|--|------------|
| 13.1.1 | All actions which direct the ball toward the opponent, with the exception of service and block, are considered as attack hits. | 12, 14.1.1 |
| 13.1.2 | During an attack hit, tipping is permitted only if the ball is cleanly hit, and not caught or thrown. | 9.2.2 |
| 13.1.3 | An attack hit is completed at the moment the ball completely crosses the vertical plane of the net or is touched by an opponent. | |

13.2 RESTRICTIONS OF THE ATTACK HIT

- | | | |
|----------|--|---------------------------------------|
| 13.2.1 | A front-row player may complete an attack hit at any height, provided that the contact with the ball has been made within the player’s own playing space (except Rules 13.2.4 and 13.3.6). | 7.4.1.1 |
| 13.2.2 | A back-row player may complete an attack hit at any height from behind the front zone: | 1.4.1,
7.4.1.2,
19.3.1.2,
D8 |
| 13.2.2.1 | at his/her take-off, the player’s foot (feet) must neither have touched nor crossed over the attack line; | 1.3.4 |
| 13.2.2.2 | after his/her hit, the player may land within the front zone. | 1.4.1 |

- | | | |
|--------|---|--------------------------|
| 13.2.3 | A back-row player may also complete an attack hit from the front zone, if at the moment of the contact a part of the ball is lower than the top of the net. | 1.4.1,
7.4.1.2,
D8 |
| 13.2.4 | No player is permitted to complete an attack hit on the OPPONENT'S service, when the ball is in the front zone and entirely higher than the top of the net. | 1.4.1 |

13.3 FAULTS OF THE ATTACK HIT

- | | | |
|--------|--|---|
| 13.3.1 | A player hits the ball within the playing space of the opposing team. | 13.2.1,
D11(20) |
| 13.3.2 | A player hits the ball "out." | 8.4,
D11(15) |
| 13.3.3 | A back-row player completes an attack hit from the front zone, if at the moment of the hit the ball is entirely higher than the top of the net. | 1.4.1,
7.4.1.2,
13.2.3,
D11(21) |
| 13.3.4 | A player completes an attack hit on the opponent's service, when the ball is in the front zone and entirely higher than the top of the net. | 1.4.1,
13.2.4,
D11(21) |
| 13.3.5 | A Libero completes an attack hit if at the moment of the hit the ball is entirely higher than the top of the net. | 19.3.1.2,
23.3.2.3d
D11(21) |
| 13.3.6 | A player completes an attack hit from higher than the top of the net when the ball is coming from an overhand finger pass by a Libero in his/her front zone. | 1.4.1,
19.3.1.4,
23.3.2.3e
D11(21) |

USAV 13.3 If an attack-hit fault occurs simultaneously with a blocking fault by the opponents, a double fault is committed.

14 BLOCK

14.1 BLOCKING

- | | | |
|--------|--|---------|
| 14.1.1 | Blocking is the action of players close to the net to intercept the ball coming from the opponent by reaching higher than the top of the net, regardless of the height of the ball contact. Only front-row players are permitted to complete a block, but at the moment of the contact with the ball, a part of the body must be higher than the top of the net. | 7.4.1.1 |
| 14.1.2 | Block Attempt
A block attempt is the action of blocking without touching the ball. | |
| 14.1.3 | Completed Block
A block is completed whenever the ball is touched by a blocker. | D7 |

14.1.4 Collective Block

A collective block is executed by two or three players close to each other and is completed when one of them touches the ball.

14.2 BLOCK CONTACT

Consecutive (quick and continuous) contacts with the ball may occur by one or more blockers, provided that the contacts are made during one action. 9.1.1, 9.2.3

USAV 14.2: A block is the interception of a ball coming from the opponents. Accordingly, it is a double contact fault if a player has successive contacts while using a blocking action when directing a ball toward the opponent during the execution of the second or third team hit.

14.3 BLOCKING WITHIN THE OPPONENT'S SPACE

In blocking, the player may place his/her hands and arms beyond the net, provided that this action does not interfere with the opponent's play. Thus, it is not permitted to touch the ball beyond the net until an opponent has executed an attack hit. 13.1.1

USAV 14.3: Blocking the ball beyond the net above the opponent's team area shall be permitted, provided:

- a. *the block is made after the opponents have hit the ball in such a manner that the ball would, in the 1st referee's judgment, clearly cross the net if not touched by a player, and no member of the attacking team is in a position to make a play on the ball.*
- b. *the ball is falling near the net, and no member of the attacking team could, in the 1st referee's judgment, make a play on the ball.*

14.4 BLOCK AND TEAM HITS

14.4.1 A block contact is not counted as a team hit. Consequently, after a block contact, a team is entitled to three hits to return the ball. 9.1, 14.4.2

14.4.2 The first hit after the block may be executed by any player, including the one who has touched the ball during the block. 14.4.1

14.5 BLOCKING THE SERVICE

To block an opponent's service is forbidden. 12, D11(12)

14.6 BLOCKING FAULTS

14.6.1 The blocker touches the ball in the OPPONENT'S 14.3 D11(20)

	space either before or simultaneously with the opponent's attack hit.	
14.6.2	A back-row player or a Libero completes a block or participates in a completed block.	14.1, 14.5, 19.3.1.3
14.6.3	Blocking the opponent's service.	14.5, D11(12)
14.6.4	The ball is sent "out" off the block.	8.4
14.6.5	Blocking the ball in the opponent's space from outside the antenna.	
14.6.6	A Libero attempts an individual or collective block.	14.1.1, 19.3.1.3

USAV 14.6: If a blocking fault is committed simultaneously with an attack-hit fault by the opponent, a double fault is committed and the rally shall be replayed.

CHAPTER 5

INTERRUPTIONS, DELAYS AND INTERVALS

See
Rules

15 INTERRUPTIONS

An interruption is the time between one completed rally and the 1st referee's whistle for the next service. The only **regular game** interruptions are TIME-OUTS and SUBSTITUTIONS.

6.1.3,
8.1, 8.2,
15.4,
15.5,
24.2.6

15.1 NUMBER OF REGULAR GAME INTERRUPTIONS

Each team may request a maximum of two time-outs and six substitutions per set.

6.2, 15.4,
15.5

For FIVB, World and Official Competitions for Seniors, the FIVB may reduce, by one, the number of team and/or Technical Time-Outs in accordance with sponsorship, marketing and broadcast agreements.

USAV 15.1: See USAV 15.6 for limitations of substitutions under USAV Domestic Competition Regulations.

15.2 SEQUENCE OF REGULAR GAME INTERRUPTIONS

15.2.1 Request for one or two time-outs, and one request for substitution by either team may follow one another, within the same interruption.

15.4,
15.5

15.2.2 However, a team is not authorized to make consecutive requests for substitution during the same interruption. Two or more players may be substituted at the same time within the same request.

15.5,
15.6.1

15.2.3 There must be a completed rally between two separate substitution requests by the same team.

6.1.3,
15.5

USAV 15.2: Rule 15.2.2 limits player(s) substitutions to one request during a game interruption. A subsequent request(s) by the same team during the same game interruption will result in an improper request.

15.3 REQUEST FOR REGULAR GAME INTERRUPTIONS

15.3.1 Regular game interruptions may be requested by the coach, or in the absence of the coach, by the game captain, and only by them.

5.1.2,
5.2,
5.3.2, 15

USAV 15.3.1: The captain may request a time-out.

15.3.2 Substitution before the start of a set is permitted, and should be recorded as a regular substitution in that set.

7.3.4

USAV 15.3.2: Time-outs before the start of a set are permitted.

15.4 TIME-OUTS AND TECHNICAL TIME-OUTS

- 15.4.1 Time-out requests must be made by showing the corresponding hand signal, when the ball is out of play and before the whistle for service. All requested time-outs last for 30 seconds. 6.1.3, 8.2, 12.3, D11(4)
For FIVB, World and Official Competitions it is obligatory to use the buzzer and then the hand signal to request time-out. D11(4)
- 15.4.2 **For FIVB, World and Official Competitions, in sets 1-4, two additional 60-second “Technical Time-Outs” are applied automatically when the leading team reaches the 8th and 16th points.** 26.2.2.3
- 15.4.3 In the deciding (5th) set, there are no “Technical Time-Outs”; only two time-outs of 30 seconds duration may be requested by each team. 15.1
- 15.4.4 During all time-outs, the players in play must go to the free zone near their bench. D1a
USAV 15.4.4: The players may remain on the court or go to the free zone near their team bench. Any member of the team listed on the roster may participate in the time-out. Coaches and non-playing team members may not enter the court. Referees may direct teams to move to the free zone near their team bench for administrative purposes. Teams may return to the court when permitted by the referees.

15.5 SUBSTITUTION

- 15.5.1 A substitution is the act by which a player, other than the Libero or his/her replacement player, after being recorded by the scorer, enters the game to occupy the position of another player, who must leave the court at that moment. 19.3.2.1 D11(5)
- 15.5.2 When the substitution is enforced through injury to a player in play this may be accompanied by the coach (or game captain) showing the corresponding hand signal. 5.1.2.3, 5.2.3.3, 8.2, 12.3, D11(5)

15.6 LIMITATION OF SUBSTITUTIONS

- 15.6.1 A player of the starting line-up may leave the game, but only once in a set, and re-enter, but only once in a set, and only to his/her previous position in the line-up. 7.3.1
- 15.6.2 A substitute player may enter the game in place of a player of the starting line-up, but only once per set, 7.3.1

and he/she can only be substituted by the same starting player.

USAV 15.6:

- a. *Twelve substitutions are the maximum permitted per team per set. Substitution of one or more players is permitted at the same time.*
- b. *A player in the starting line-up may leave the set and re-enter, but only in his/her previous position in the line-up (Exception 15.7).*
- c. *A substitute may enter a set in the position of a teammate in the starting line-up.*
- d. *Unlimited individual entries by a substitute within the team's allowable 12 substitutions are permitted. Each entry must be in the same position in the line-up.*
- e. *More than one substitute may enter the set in each position.*

15.7 EXCEPTIONAL SUBSTITUTION

A player (except the Libero) who cannot continue playing due to injury or illness, should be substituted legally. If this is not possible, the team is entitled to make an EXCEPTIONAL substitution, beyond the limits of Rule 15.6.

An exceptional substitution means that any player who is not on the court at the time of the injury/illness, except the Libero, second Libero or their regular replacement player, may be substituted into the game for the injured/ill player. The substituted injured/ill player is not allowed to re-enter the match. An exceptional substitution cannot be counted in any case as a regular substitution, but should be recorded on the score sheet as part of the total substitutions in the set and the match.

USAV 15.7a: Priority for exceptional substitution:

- i. *by the starter or a substitute who has played in the position of the injured player, or by any substitute who has not already participated in the set;*
- ii. *by any substitute on the bench, regardless of position previously played;*
- iii. *by the Libero.*

15.8 SUBSTITUTION FOR EXPULSION OR DISQUALIFICATION

An EXPELLED or DISQUALIFIED player must be substituted immediately through a legal substitution. If this is not possible, the team is declared INCOMPLETE.

15.6,
19.4.3

6.4.3,
7.3.1, 15.6,
21.3.2,
21.3.3,
D11(5)

15.9 ILLEGAL SUBSTITUTION

- 15.9.1 A substitution is illegal, if it exceeds the limitations indicated in Rule 15.6 (except the case of Rule 15.7), or an unregistered player is involved.
- USAV 15.9.1: The following substitutes are illegal:*
- a. player not on the roster;
 - b. player with illegal number or uniform;
 - c. exceeds the number of total team substitutions;
 - d. player expelled or disqualified;
 - e. player replaced by exceptional substitution.
- 15.9.2 When a team has made an illegal substitution and the play has been resumed the following procedure shall apply, in sequence:
- 15.9.2.1 the team is penalized with a point and service to the opponent;
 - 15.9.2.2 the substitution must be rectified;
 - 15.9.2.3 the points scored by the team at fault since the fault was committed are cancelled; the opponent's points remain valid.
- USAV 15.9.2.3: No substitution will be charged to the team or player(s), even if required to correct the wrong entry. In addition, any player or team substitutions charged at the time of the wrong entry shall be removed from the score sheet as though they had never occurred.*

15.10 SUBSTITUTION PROCEDURE

- 15.10.1 Substitution must be carried out within the substitution zone.
- 15.10.2 A substitution shall only last the time needed for recording the substitution on the score sheet, and allowing entry and exit of the players.
- 15.10.3a The actual request for substitution starts at the moment of the entrance of the substitute player(s) into the substitution zone, ready to play, during an interruption. The coach does not need to make a substitution hand signal except if the substitution is for injury or before the start of the set.
- 15.10.3b If the player is not ready, the substitution is not granted and the team is sanctioned for a delay.
- 15.10.3c The request for substitution is acknowledged and announced by the scorer or 2nd referee, by

use of the buzzer or whistle respectively. The 2nd referee authorizes the substitution.

For FIVB, World and Official Competitions, numbered paddles are used to facilitate the substitution.

- 15.10.4 If a team intends to make simultaneously more than one substitution, all substitute players must enter the substitution zone at the same time to be considered in the same request. In this case, substitutions must be made in succession, one pair of players after another. If one is illegal, the legal one(s) is/are granted and the illegal is rejected and subject to a delay sanction.

USAV 15.10.4: Any significant delay between in coming substitutes entering the substitution zone shall result in the team being limited to one substitute.

15.11 IMPROPER REQUESTS

- 15.11.1 It is improper to request any regular game interruption:
- 15.11.1.1 during a rally or at the moment of or after the whistle to serve;
 - 15.11.1.2 by a non-authorized team member;
 - 15.11.1.3 for a second substitution by the same team during the same interruption, except in the case of injury/illness of a player in play;
 - 15.11.1.4 after having exhausted the authorized number of time-outs and substitutions.
- 15.11.2 The first improper request by a team in the match that does not affect or delay the game shall be rejected, but it must be recorded on the score sheet without any other consequences.

USAV 15.11.2: If a change in request is due to a referee's mind change, the request will be honored and no sanction assessed.

- 15.11.3 Any further improper request in the match by the same team constitutes a delay.

USAV 15.11: A request for first or second time-out may be honored immediately subsequent to an improper request for substitution. A proper request for substitution may be honored immediately subsequent to an improper request for time-out.

16 GAME DELAYS

16.1 TYPES OF DELAYS

An improper action of a team that defers resumption of the game is a delay and includes, among others:

- 16.1.1 delaying regular game interruptions; 15.10.2
- 16.1.2 prolonging interruptions, after having been instructed to resume the game; 15
- 16.1.3 requesting an illegal substitution; 15.9
- 16.1.4 repeating an improper request; 15.11.3
- 16.1.5 delaying the game by a team member.

USAV 16.1: A request for an illegal substitution or excess time-out shall result in an improper request. However, if such a request is acknowledged (i.e., whistled), a delay sanction shall result. No additional request for game interruption from that team may be made until the next completed rally. Any substitution request that is improper or causes a delay is denied.

16.2 DELAY SANCTIONS

- 16.2.1 "Delay warning" and "delay penalty" are team sanctions. D9
 - 16.2.1.1 Delay sanctions remain in force for the entire match. 6.3
 - 16.2.1.2 All delay sanctions are recorded on the score sheet. 25.2.2.6
- 16.2.2 The first delay in the match by a team member is sanctioned with a "DELAY WARNING." 4.1.1, D11(25)
- 16.2.3 The second and subsequent delays of any type by any member of the same team in the same match constitute a fault and are sanctioned with a "DELAY PENALTY": a point and service to the opponent. 6.1.3, D11(25)
- 16.2.4 Delay sanctions imposed before or between sets are applied in the following set.

17 EXCEPTIONAL GAME INTERRUPTIONS

17.1 INJURY/ILLNESS

- 17.1.1 Should a serious accident occur while the ball is in play, the referee must stop the game immediately and permit medical assistance to enter the court. The rally is then replayed. 8.1
6.1.3

USAV 17.1.1: If the injured player cannot continue playing within 30 seconds, the player must be replaced by substitution, a legal Libero replacement

(if the Libero is not on the court at the time of the injury), or the team must take a legal time-out.

- a. If the referees are informed within 30 seconds that a substitute will replace the injured player, no time-out will be charged regardless of the time required to remove the player safely from the playing area.*
- b. No substitution requests may be made by the injured player's team until the injury situation is resolved.*

- 17.1.2 If an injured/ill player cannot be substituted legally or exceptionally, the player is given a 3-minute recovery time, but not more than once for the same player in the match. If the player does not recover, his/her team is declared incomplete. 15.6, 15.7, 24.2.8, 6.4.3, 7.3.1

17.2 EXTERNAL INTERFERENCE

If there is any external interference during the game, the play has to be stopped and the rally is replayed. 6.1.3, D11(23)

USAV 17.2: If an injured player is unable to play and a legal or exceptional substitution cannot be made, the referee must grant a special time-out of up to three minutes. Play will be resumed as soon as the injured player is able to continue. In no case shall the special injury time-out exceed three minutes. After the special time-out, a team may request a legal time-out. If, after three minutes, or at the expiration of time-outs granted subsequent to the special time-out, the injured player cannot continue to play, the team is declared incomplete. No player may be granted more than one three-minute injury time-out during any match. If a player becomes injured to the extent that a second injury time-out would be required, the team is declared incomplete.

17.3 PROLONGED INTERRUPTIONS

- 17.3.1 If unforeseen circumstances interrupt the match, the 1st referee, the organizer and the Control Committee, if there is one, shall decide the measures to be taken to re-establish normal conditions. 23.2.3
- 17.3.2 Should one or several interruptions occur, not exceeding 4 hours in total: 17.3.1
- 17.3.2.1 if the match is resumed on the same playing court, the interrupted set shall continue normally with the same score, players (except expelled or disqualified) 1, 7.3

- ones) and positions. The sets already played will keep their scores;
- 17.3.2.2 if the match is resumed on another playing court, the interrupted set is cancelled and replayed with the same team members and the same starting line-ups (except expelled or disqualified ones) and the record of all sanctions will be maintained. The sets already played will keep their scores.

7.3,
21.4.1,
D9

USAV 17.3.2.2: If the match is resumed on another playing court, the interrupted set shall continue normally with the same score, players (except expelled or disqualified ones) and positions. The sets already played will keep their scores.

USAV 17.3.2: For tournament play where a court change is necessitated, the match will be continued from the point of the interruption.

- 17.3.3 Should one or several interruptions occur, exceeding 4 hours in total, the whole match shall be replayed.

18 INTERVALS AND CHANGE OF COURTS

18.1 INTERVALS

An interval is the time between sets. All intervals last 3 minutes. During this period of time, the change of courts and line-up registrations of the teams on the score sheet are made.

4.2.4
7.3.2,
18.2,
25.2.1.2

The interval between the second and the third set can be extended up to 10 minutes by the competent body at the request of the organizer.

18.2 CHANGE OF COURTS

- 18.2.1 After each set, the teams change courts, with the exception of the deciding set.
- 18.2.2 In the deciding set, once the leading team reaches 8 points, the teams change courts without delay and the player positions remain the same. If the change is not made once the leading team reaches 8 points, it will take place as soon as the error is noticed. The score at the time that the change is made remains the same.

D11(3)
7.1
6.3.2,
7.4.1,
25.2.2.5

CHAPTER 6

THE LIBERO PLAYER

19 THE LIBERO PLAYER

See
Rules

19.1 DESIGNATION OF THE LIBERO

5

- 19.1.1 Each team has the right to designate from the list of players on the score sheet up to two (2) specialist defensive players: Liberos.

4.1.1

In FIVB, World and Official Competitions for Seniors, if a team has more than 12 players recorded in the score sheet, TWO Liberos are mandatory in the team list.

USAV 19.1.1: Each team has the right to designate from the list of players on the score sheet (roster) up to two specialized defensive players called Liberos. If the team chooses to designate two Liberos at the start of the match, they are designated as Liberos for the entire match. If the team chooses to designate only one Libero (or no Libero) at the start of the match, the team may choose to change the player designated as Libero for each set including playing any set with no Libero, but may not designate a second Libero for any subsequent set in the match.

- 19.1.2 All Liberos must be recorded on the score sheet in the special lines reserved for this.

5.2.2,
25.2.1.1,
26.2.1.1

- 19.1.3 The Libero on court is the Acting Libero. If there is another Libero, he/she is the second Libero for the team. Only one Libero may be on court at any time.

19.2 EQUIPMENT

4.3

The Libero player(s) must wear a uniform (OR JACKET/BIB FOR THE RE-DESIGNATED Libero) which has a different dominant color from any color of the rest of the team. The uniform must clearly contrast with the rest of the team. The Libero uniforms must be numbered like the rest of the team.

For FIVB, World and Official Competitions, the re-designated Libero should, if possible, wear the same style and color of jersey as the original Libero, but should keep his/her own number.

USAV 19.2:

- a. *The Libero and/or his/her teammates shall wear a solid-*

- colored uniform top. Regarding the solid-colored top:*
- (a). *The solid color uniform top shall clearly contrast from the predominant color(s) of the teammates' uniform top. Predominant color(s) is the color(s) appearing on approximately half of the uniform.*
 - (b). *Sleeves shall be the same color as the body of the uniform top.*
 - (c). *Piping/trim not exceeding 1 inch in total at its widest point may be placed along the seams and may be a different color(s) than the uniform top.*
 - (d). *Lettering and collars may be different color(s) than the uniform top.*
 - (e). *Numbers shall be a contrasting color to the uniform top and meet all other specifications in USAV 4.3.3.1. Color combinations such as purple/black, dark green/black, navy/maroon, and white/light yellow are not distinctive enough to comply with the rules.*
- b. *A jacket or bib can only be worn by the redesignated Libero. If a jacket or bib is worn by the redesignated Libero, the uniform number must still be visible.*

19.3 ACTIONS INVOLVING THE LIBERO

- | | | |
|----------|--|---|
| 19.3.1 | The playing actions: | |
| 19.3.1.1 | the Libero is allowed to replace any player in a back-row position; | 7.4.1.2 |
| 19.3.1.2 | he/she is restricted to perform as a back-row player and is not allowed to complete an attack hit from anywhere (including playing court and free zone) if at the moment of the contact the ball is entirely higher than the top of the net; | 13.2.2,
13.2.3,
13.3.5 |
| 19.3.1.3 | he/she may not serve, block or attempt to block; | 12.4.1,
14.6.2,
14.6.6,
D11(12) |
| | <i>USAV 19.3.1.3:</i> | |
| | <i>a. The Libero may not block or attempt to block.</i> | |
| | <i>b. In one position a Libero may serve after replacing the player in position 1.</i> | |
| 19.3.1.4 | a player may not complete an attack hit when the ball is entirely higher than the top of the net, if the ball is coming from an overhand finger pass by a Libero in his/her front zone. The ball may be | 1.4.1,
13.3.6,
23.3.2.3d, e,
D1b |

	freely attacked if the Libero makes the same action from outside his/her front zone.	
19.3.2	Libero Replacements	
19.3.2.1	Libero Replacements are not counted as substitutions. They are unlimited but there must be a completed rally between two Libero replacements (unless a penalty causes the team to rotate and the Libero to move to position four, or the Acting Libero becomes unable to play, making the rally incomplete). <i>USAV 19.3.2.1: In one rotation, a Libero can replace the player in position 1 and serve the next rally, even if he/she is already on the court in replacement of another player. In this situation, the Libero does not have to exit the court before replacing the player in position 1, and there does not need to be a completed rally between Libero replacements.</i>	6.1.3, 15.5
19.3.2.2	The regular replacement player may replace and be replaced by either Libero. The Acting Libero can only be replaced by the regular replacement player for that position or by the second Libero.	
19.3.2.3	At the start of each set, the Libero cannot enter the court until the 2 nd referee has checked the line-up and authorized a Libero replacement with a starting player.	7.3.2, 12.1
19.3.2.4	Other Libero replacements must only take place while the ball is out of play and before the whistle for service.	8.2, 12.3
19.3.2.5	A Libero replacement made after the whistle for service but before the service hit should not be rejected; however, at the end of the rally, the game captain must be informed that this is not a permitted procedure, and that repetition will be subject to delay sanctions.	12.3, 12.4, D9
19.3.2.6	Subsequent late Libero replacements shall result in the play being interrupted immediately, and the imposition of a delay sanction. The team to serve next will be determined by the level of the delay sanction.	16.2, D9

19.3.2.7	The Libero and the replacing player may only enter or leave the court through the Libero Replacement Zone.	1.4.4, D1b
19.3.2.8	Libero replacements must be recorded on the Libero Control Sheet (if one is used) or on the electronic score sheet.	26.2.2.1, 26.2.2.2
19.3.2.9	An illegal Libero replacement can involve (amongst others): –no completed rally between Libero replacements; –the Libero being replaced by a player other than the second Libero or the regular replacement player. An illegal Libero replacement should be considered in the same way as an illegal substitution: should the illegal Libero replacement be noticed before the start of the next rally, then this is corrected by the referees, and the team is sanctioned for delay; should the illegal Libero replacement be noticed after the service hit, the consequences are the same as for an illegal substitution.	6.1.3 15.9 15.9 D9 15.9

19.4 RE-DESIGNATION OF A NEW LIBERO

19.4.1	The Libero becomes unable to play if injured, ill, expelled or disqualified. The Libero can be declared unable to play for any reason by the coach or, in the absence of a coach, by the game captain.	21.3.2, 21.3.3, D9 5.1.2.1, 5.2.1
19.4.2	Team with one Libero	
19.4.2.1	When only one Libero is available for a team according to Rule 19.4.1, or the team has only one registered, and this Libero becomes or is declared unable to play, the coach (or game captain if no coach is present) may re-designate as Libero for the remainder of the match any other player (replacement player excepted) not on the court at the moment of the re-designation.	19.4, 19.4.1
19.4.2.2	If the Acting Libero becomes unable to play, he/she may be replaced by the reg-	

	ular replacement player or immediately and directly to court by a re-designated Libero. However, a Libero who is the subject of a re-designation may not play for the remainder of the match. If the Libero is not on court when declared unable to play, he/she may also be the subject of a re-designation. The Libero declared unable to play may not play for the remainder of the match.	
19.4.2.3	The coach, or game captain if no coach is present, contacts the second referee informing him/her about the re-designation.	5.1.2.1, 5.2.1
19.4.2.4	Should a re-designated Libero become or be declared unable to play, further re-designations are permitted.	19.4.1
19.4.2.5	If the coach requests the team captain to be re-designated as the new Libero, this will be permitted—but the team captain must in this case relinquish all leadership privileges.	5.1.2, 19.4.1
	<i>USAV 19.4.2.5: If the coach requests the team captain to be re-designated as the new Libero, this will be permitted and the team captain retains all leadership privileges.</i>	
19.4.2.6	In the case of a re-designated Libero, the number of the player re-designated as Libero must be recorded on the score sheet remarks section and on the Libero control sheet (or electronic score sheet if one is used).	25.2.2.7, 26.2.2.1
19.4.3	Team with two Liberors	
19.4.3.1	Where a team has registered on the score sheet two Liberors, but one becomes unable to play the team has the right to play with only one Libero. No re-designation will be allowed, however, unless the remaining Libero is unable to continue playing for the match.	4.1.1, 19.1.1 19.4
19.5 SUMMARY		
19.5.1	If the Libero is expelled or disqualified, he/she may be replaced immediately by the team's second Libero. Should the team have only one Libero, then it has the right to make a re-designation.	19.4, 21.3.2, 21.3.3

CHAPTER 7

PARTICIPANTS' CONDUCT

20 REQUIREMENTS OF CONDUCT

See
Rules

20.1 SPORTSMANLIKE CONDUCT

- 20.1.1 Participants must know the "Official Volleyball Rules" and abide by them.

USAV 20.1.1: Participants must also know the "Domestic Competition Regulations" and abide by them.

- 20.1.2 Participants must accept referees' decisions with sportsmanlike conduct, without disputing them. In case of doubt, clarification may be requested only through the game captain. 5.1.2.1
- 20.1.3 Participants must refrain from actions or attitudes aimed at influencing the decisions of the referees or covering up faults committed by their team.

20.2 FAIR PLAY

- 20.2.1 Participants must behave respectfully and courteously in the spirit of FAIR PLAY, not only toward the referees, but also toward other officials, the opponent, teammates and spectators.
- 20.2.2 Communication between team members during the match is permitted. 5.2.3.4

21 MISCONDUCT AND ITS SANCTIONS

21.1 MINOR MISCONDUCT

Minor misconduct offenses are not subject to sanctions. It is the 1st referee's duty to prevent the teams from approaching the sanctioning level. This is done in two stages: Stage 1: by issuing a verbal warning through the game captain; Stage 2: by use of a YELLOW CARD to the team member(s) concerned. This formal warning is not in itself a sanction but a symbol that the team member (and by extension the team) has reached the sanctioning level for the match. It is recorded in the score sheet but has no immediate consequences. 5.1.2, 21.3 D9, D11(6a)

Note: Yellow card warnings are assessed to individuals, but are in force for the entire team. This means that each team may only receive one yellow card per match.

21.2 MISCONDUCT LEADING TO SANCTIONS

Incorrect conduct by a team member toward officials, opponents, teammates or spectators is classified in three categories according to the seriousness of the offense.

- 21.2.1 Rude conduct: action contrary to good manners or moral principles.
- 21.2.2 Offensive conduct: defamatory or insulting words or gestures or any action expressing contempt.
- 21.2.3 Aggression: actual physical attack or aggressive or threatening behavior.

4.1.1

21.3 SANCTION SCALE

According to the judgment of the 1st referee and depending on the seriousness of the offense, the sanctions to be applied and recorded on the score sheet are: **Penalty, Expulsion or Disqualification.**

D9
21.2,
25.2.2.6

21.3.1 Penalty

The first rude conduct in the match by any team member is penalized with a point and service to the opponent.

D11(6b)
4.1.1,
21.2.1

21.3.2 Expulsion

21.3.2.1 A team member who is sanctioned by expulsion shall not play for the rest of the set, must be substituted legally and immediately if on court and must remain seated in the penalty area with no other consequences. An expelled coach loses his/her right to intervene in the set and must remain seated in the penalty area.

D11(7)
1.4.6,
4.1.1,
5.2.1,
5.3.2,
D1a,D1b
5.2.3.3

USAV 21.3.2.1: When facility space does not allow for a penalty area, a player or substitute who is sanctioned by expulsion shall not play for the rest of the set and must remain seated on his/her bench for the remainder of the set. Any other team member sanctioned by expulsion must leave the playing area, bench and warm-up area for the remainder of the set.

- 21.3.2.2 The first offensive conduct by a team member is sanctioned by expulsion with no other consequences.

4.1.1,
21.2.2

21.3.2.3	The second rude conduct in the same match by the same team member is sanctioned by expulsion with no other consequences.	4.1.1, 21.2.1
21.3.3	Disqualification	D11(8)
21.3.3.1	A team member who is sanctioned by disqualification must be substituted legally and immediately if on court and must leave the Competition-Control Area for the rest of the match with no other consequences. <i>USAV 21.3.3.1: As a minimum, the Competition Control Area includes the playing area, bench, warm-up area and spectator area.</i>	4.1.1, D1a
21.3.3.2	The first physical attack or implied or threatened aggression is sanctioned by disqualification with no other consequences.	21.2.3
21.3.3.3	The second offensive conduct in the same match by the same team member is sanctioned by disqualification with no other consequences.	4.1.1, 21.2.2
21.3.3.4	The third rude conduct in the same match by the same team member is sanctioned by disqualification with no other consequences.	4.1.1, 21.2.1

21.4 APPLICATION OF MISCONDUCT SANCTIONS

21.4.1	All misconduct sanctions are individual sanctions, remain in force for the entire match and are recorded on the score sheet.	21.3, 25.2.2.6
21.4.2	The repetition of misconduct by the same team member in the same match is sanctioned progressively (the team member receives a heavier sanction for each successive offense).	4.1.1, 21.2, 21.3, D9
21.4.3	Expulsion or disqualification due to offensive conduct or aggression does not require a previous sanction.	21.2, 21.3

21.5 MISCONDUCT BEFORE AND BETWEEN SETS

Any misconduct occurring before or between sets is sanctioned according to Rule 21.3 and sanctions apply in the following set.	18.1, 21.2, 21.3
--	------------------------

SECTION II
THE REFEREES, THEIR RESPONSIBILITIES
AND OFFICIAL HAND SIGNALS

CHAPTER 8

REFEREES

22 REFEREEING CORPS AND PROCEDURES

**See
Rules**

22.1 COMPOSITION

The refereeing corps for a match is composed of the following officials:

- the 1st referee; 23
- the 2nd referee; 24
- the scorer; 25
- four (two) line judges. 27

Their location is shown in Diagram 10.

For FIVB, World and Official Competitions an assistant scorer is compulsory. 26

USAV 22.1: For all USAV competition, the assistant scorer is a compulsory member of the referee corps.

22.2 PROCEDURES

22.2.1 Only the 1st and 2nd referees may blow a whistle during the match:

USAV 22.2.1: The scorer may use an audible device, including a whistle, to notify the referees of a rotational fault.

22.2.1.1 the 1st referee gives the signal for the service that begins the rally; 6.1.3, 12.3

22.2.1.2 the 1st or 2nd referee signals the end of the rally, provided that they are sure that a fault has been committed and they have identified its nature.

22.2.2 They may blow the whistle when the ball is out of play to indicate that they authorize or reject a team request. 5.1.2, 8.2

22.2.3 Immediately after the referee's whistle to signal the completion of the rally, they have to indicate with the official hand signals: 22.2.1.2, 28.1

- 22.2.3.1 If the fault is whistled by the 1st referee, he/she will indicate in order:
- a) the team to serve; 12.2.2, D11(2)
 - b) the nature of the fault;

	c) the player(s) at fault (if necessary).	
	<u>USAV 22.2.3.1: The 2nd referee will follow the 1st referee's hand signals by repeating them.</u>	
22.2.3.2	If the fault is whistled by the 2 nd referee, he/she will indicate: a) the nature of the fault; b) the player at fault (if necessary); c) the team to serve following the hand signal of the 1 st referee. In this case, the 1 st referee does not show either the nature of the fault or the player at fault, but only the team to serve.	12.2.2 D11(2)
22.2.3.3	In the case of an attack hit fault <u>or blocking fault</u> by back-row or Libero players, both referees indicate according to 22.2.3.1 and 22.2.3.2 above.	12.2.2, 13.3.3, 13.3.5, 19.3.1.2, 23.2.3d,e, D11(21)
22.2.3.4	In the case of a double fault both referees indicate in order: a) the nature of the fault; b) the players at fault (if necessary). <u>The team to serve next is then indicated by the 1st referee.</u>	17.3, D11(23) 12.2.2, D11(2)

23 1ST REFEREE

23.1 LOCATION

The 1st referee carries out his/her functions standing on a referee's stand located at one end of the net on the opposite side to the scorer. His/her view must be approximately 50 cm (19^{1/2}") above the net.

D1a,
D1b,
D10

23.2 AUTHORITY

23.2.1 The 1st referee directs the match from the start until the end. He/she has authority over all members of the refereeing corps and the members of the teams. During the match his/her decisions are final. He/she is authorized to overrule the decisions of other members of the refereeing corps, if it is noticed that they are mistaken. He/she may even replace a member of the refereeing corps who is not performing his/her functions properly.

4.1.1,
6.3

23.2.2	He/she also controls the work of the ball retrievers, floor wipers and moppers.	3.3
23.2.3	He/she has the power to decide any matters involving the game, including those not provided for in the rules.	
23.2.4	He/she shall not permit any discussion about his/her decisions.	20.1.2
	However, at the request of the game captain, the 1 st referee will give an explanation on the application or interpretation of the rules upon which he/she has based the decision.	5.1.2.1
	If the game captain does not agree with this explanation and chooses to protest against such decision, he/she must immediately reserve the right to file and record this protest at the conclusion of the match. The 1 st referee must authorize this right of the game captain.	5.1.2.1, 5.1.3.2, 25.2.3.2
	<i>USAV 23.2.4: For the Protest Procedures, see USAV 5.1.2.1.</i>	
23.2.5	The 1 st referee is responsible for determining before and during the match whether the playing area equipment and the conditions meet playing requirements.	Chapter 1, 23.3.1.1

23.3 RESPONSIBILITIES

23.3.1	Prior to the match, the 1 st referee:	
	23.3.1.1 inspects the conditions of the playing area, the balls and other equipment;	Chapter 1, 23.2.5
	23.3.1.2 performs the toss with the team captains;	7.1
	23.3.1.3 controls the teams' warming-up.	7.2
23.3.2	During the match, he/she is authorized:	
	23.3.2.1 to issue warnings to the teams;	21.1
	23.3.2.2 to sanction misconduct and delays;	16,21,2, D9, D11(6a, 6b, 7, 8, 25)
	23.3.2.3 to decide upon:	
	a) the faults of the server and of the positions of the serving team, including the screen;	7.5, 12.4, 12.5, 12.7.1, D4, D6, D11(12, 13)

	b) the faults in playing the ball;	9.3, D11(16, 17)
	c) the faults above the net, and the faulty contact of the player with the net, primarily on the attacker's side;	11.3.1, 11.4.1, 11.4.4, D11(20) 13.3.3,
	d) the attack hit faults of the Libero and back-row players;	13.3.5, 24.3.2.4, D8, D11(21)
	e) the completed attack hits made by a player on a ball above net height coming from an overhand pass with fingers by the Libero in his/her front zone;	1.4.1, 13.3.6, 24.3.2.4, D11(21)
	f) the ball crossing completely the lower space under the net;	8.4.5, 24.3.2.7, D5a, D11(22)
	g) the completed block by back-row players or the attempted block by the Libero.	14.6.2, 14.6.6, D11(12)
23.3.3	At the end of the match, he/she checks the score sheet and signs it.	24.3.3, 25.2.3.3

24 2nd REFEREE

24.1 LOCATION

The 2nd referee performs his/her functions standing outside the playing court near the post, on the opposite side of and facing the 1st referee. D1a,
D1b,
D10

24.2 AUTHORITY

24.2.1	The 2 nd referee is the assistant of the 1 st referee, but has also his/her own range of jurisdiction. Should the 1 st referee become unable to continue his/her work, the 2 nd referee may replace him/her.	24.3
24.2.2	He/she may, without whistling, also signal faults outside his/her range of jurisdiction, but may not insist on them to the 1 st referee.	24.3
24.2.3	He/she controls the work of the scorer(s).	25.2, 26.2
24.2.4	He/she supervises the team members on the team bench and reports their misconduct to the 1 st referee.	4.2.1

24.2.5	He/she controls the players in the warm-up areas.	4.2.3
24.2.6	He/she authorizes the regular game interruptions, controls their duration and rejects improper requests. <i>USAV 24.2.6: The 2nd referee is responsible for starting and ending the Technical Time-out.</i>	15, 15.11, 25.2.2.3
24.2.7	He/she controls the number of time-outs and substitutions used by each team and reports the 2 nd time-out and 5 th and 6 th substitutions to the 1 st referee and the coach concerned. <i>USAV 24.2.7: The 2nd referee reports substitutions 9, 10, 11 and 12 to the 1st referee and the appropriate coach, or game captain; report substitution 12 to the 1st referee.</i>	15.1, 25.2.2.3
24.2.8	In the case of an injury of a player, he/she authorizes an exceptional substitution or grants a 3-minute recovery time.	15.7, 17.1.2
24.2.9	He/she checks the floor condition, mainly in the front zone. He/she also checks, during the match, that the balls still fulfill the regulations.	1.2.1, 3
24.2.10	He/she supervises the team members in the penalty areas and reports their misconduct to the 1 st referee. For FIVB, World and Official Competitions, the duties recorded under 24.2.5 and 24.2.10 are carried out by the Reserve Referee.	1.4.6, 21.3.2

24.3 RESPONSIBILITIES

24.3.1	At the start of each set, at the change of courts in the deciding set and whenever necessary, the 2 nd referee checks that the actual positions of the players on the court correspond to those on the line-up sheets. <i>USAV 24.3.1: The 2nd referee's check of the line-up is a courtesy. The responsibility to ensure that the correct players are on the court rests with the captain and/or coach.</i>	5.2.3.1, 7.3.2, 7.3.5, 18.2.2
24.3.2	During the match, he/she decides, whistles and signals:	
24.3.2.1	penetration into the opponent's court, and the space under the net;	1.3.3, 11.2.D5a, D11(22)
24.3.2.2	positional faults of the receiving team;	7.5.D4, D11(13)
24.3.2.3	the faulty contact of the player with the net primarily on the blocker's side and with the	11.3.1

	antenna on his/her side of the court;	
	<i>USAV 24.3.2.3: The 2nd referee decides, whistles and signals the faulty contact by a player with any portion of the net.</i>	
24.3.2.4	the completed block by back-row players or the attempted block by the Libero; or the attack hit fault by back-row players or by the Libero;	13.3.3, 14.6.2, 14.6.6, 23.3.2.3. d, e, g, D11(12, 21)
	<i>USAV 24.3.2.4: The 1st referee and the 2nd referee decide, whistle and signal the attack-hit faults of the Libero and back-row players.</i>	
24.3.2.5	the contact of the ball with an outside object;	8.4.2, 8.4.3, D11(15)
24.3.2.6	the contact of the ball with the floor when the 1 st referee is not in position to see the contact;	8.3
24.3.2.7	the ball that crosses the net totally or partly outside the crossing space to the opponent's court or contacts the antenna on his/her side of the court.	8.4.3, 8.4.4, D5a, D11(15)
24.3.3	At the end of the match, he/she checks and signs the score sheet.	23.3.3, 25.2.3.3
	<i>USAV 24.3.3: At the end of the match, he/she is not required to sign the score sheet, but is still required to check the score sheet for accuracy.</i>	

25 SCORER

25.1 LOCATION

The scorer performs his/her functions seated at the scorer's table on the opposite side of the court from and facing the 1st referee.

D1a,
D1b,
D10

25.2 RESPONSIBILITIES

He/she keeps the score sheet according to the rules, cooperating with the 2nd referee.

He/she uses a buzzer or other sound device to notify irregularities or give signals to the referees on the basis of his/her responsibilities.

25.2.1 Prior to the match and set, the scorer:

25.2.1.1 registers the data of the match and

4.1, 5.1.1

	teams, including the names and numbers of the Liberos, according to the procedures in force, and obtains the signatures of the captains and the coaches;	5.2.2, 7.3.2, 19.1.2, 19.4.2.6
	<i>USAV 25.2.1.1: The captains and coaches do not sign the score sheet before the match.</i>	
25.2.1.2	records the starting line-up of each team from the line-up sheet. If he/she fails to receive the line-up sheets on time, he/she immediately notifies this fact to the 2 nd referee.	5.2.3.1, 7.3.2 5.2.3.1
25.2.2	During the match, the scorer:	
25.2.2.1	records the points scored;	6.1
25.2.2.2	controls the serving order of each team and indicates any error to the referees immediately after the service hit;	12.2
25.2.2.3	is empowered to acknowledge and announce requests for player substitutions by use of the buzzer, controlling their number, and records the substitutions and time-outs, informing the 2 nd referee;	15.1, 15.4.1, 15.10.3c, 24.2.6, 24.2.7
25.2.2.4	notifies the referees of a request for regular game interruption that is out of order;	15.11
25.2.2.5	announces to the referees the ends of the sets, and the scoring of the 8 th point in the deciding set;	6.2, 15.4.1, 18.2.2
25.2.2.6	records misconduct warnings, sanctions and improper requests;	15.11.3 16.2, 21.3
25.2.2.7	records all other events as instructed by the 2 nd referee, i.e. exceptional substitutions, recovery time, prolonged interruptions, external interference, re-designation, etc.;	15.7, 17.1.2 17.2, 17.3, 19.4
25.2.2.8	controls the interval between sets.	18.1
	<i>USAV 25.2.2.8: This function is performed by the referees.</i>	
25.2.3	At the end of the match, the scorer:	
25.2.3.1	records the final result;	6.3
25.2.3.2	in the case of protest, with the previous authorization of the 1 st referee, writes or permits the team/game captain to write on the score sheet a statement on the incident being protested;	5.1.2.1, 5.1.3.2, 23.2.4

25.2.3.3	signs the score sheet him/herself, before obtaining the signatures of the team captains and then the referees.	5.1.3.1, 23.3.3, 24.3.3
	<i>USAV 25.2.3.3: The 2nd referee is not required to sign the score sheet(s). It is no longer required that either coach sign the score sheet after the match to verify the results.</i>	

26 ASSISTANT SCORER

26.1 LOCATION

The assistant scorer performs his/her functions seated beside the scorer at the scorer's table.

221, D1a,
D1b, D10

26.2 RESPONSIBILITIES

He/she records the replacements involving the Libero. He/she assists with the administrative duties of the scorer's work.

19.3

Should the scorer become unable to continue his/her work, the assistant scorer substitutes for the scorer.

26.2.1 Prior to the match and set, the assistant scorer:

26.2.1.1 prepares the Libero control sheet;

26.2.1.2 prepares the reserve score sheet.

26.2.2 During the match, the assistant scorer:

26.2.2.1 records the details of the Libero replacements/re-designations;

19.3.1.1,
19.4

USAV 26.2.2.1: In addition to recording the details of the Libero replacements, the assistant scorer records all substitutions.

26.2.2.2 notifies the referees of any fault of the Libero replacement by using the buzzer;

19.3.2

26.2.2.3 starts and ends the timing of Technical Time-outs;

15.4.1

USAV 26.2.2.3: The 2nd referee is responsible for starting and ending the Technical Time-out.

26.2.2.4 operates the manual scoreboard on the scorer's table;

USAV 26.2.2.4: It is recommended that someone other than the assistant scorer operate the visual scoreboard.

	26.2.2.5	checks that the scoreboards agree;	25.2.2.1
	26.2.2.6	if necessary, updates the reserve score sheet and gives it to the scorer.	25.2.1.1
16.2.2.3		At the end of the match, the assistant scorer:	
	26.2.3.1	signs the Libero control sheet and submits it for checking,	
	26.2.3.2	signs the score sheet.	
		For FIVB, World and Official Competitions which use an e-score sheet, the Assistant Scorer acts with the Scorer to announce the substitutions and identify the Libero replacements.	
		<i>USAV 26.2.3: The assistant scorer does not sign the Libero control sheet or the score sheet.</i>	

27 LINE JUDGES

27.1 LOCATION

If only two line judges are used, they stand at the corners of the court closest to the right hand of each referee, diagonally at 1 to 2 m (39" to 6'6^{3/4"}) from the corner. Each one of them controls both the end line and side line on his/her side.

USAV 27.1: If two line judges are used, they stand at the corners of the court closest to the right hand of each referee.

For FIVB, World and Official Competitions, it is compulsory to have four line judges. They stand in the free zone at 1 to 3 m (39" to 9'10") from each corner of the court, on the imaginary extension of the line that they control.

27.2 RESPONSIBILITIES

	27.2.1	The line judges perform their functions by using flags (40 X 40 cm) (16" X 16"), to signal:	D12
	27.2.1.1	the ball "in" and "out" whenever the ball lands near their line(s);	8.3, 8.4, D12(1,2)
	27.2.1.2	the touches of "out" balls by the team receiving the ball;	8.4, D12(3)
	27.2.1.3	the ball touching the antenna, the served ball and the third hit of the team crossing the net outside the crossing space, etc.;	8.4.3, 8.4.4, 10.1.1, D5a, D12(4)

27.2.1.4	any player (except the server) stepping outside of his/her court at the moment of the service hit;	7.4, 12.4.3, D12(4)
27.2.1.5	the foot faults of the server;	12.4.3
27.2.1.6	any contact with the top 80 cm (32") of the antenna on their side of the court by any player during his/her action of playing the ball or interfering with the play; <i>USAV 27.2.1.6: The decision regarding any contact with the antenna by any player during his/her action of playing the ball or interfering with the play is that of the 1st and 2nd referee. The decision is not a responsibility of the line judge.</i>	11.3.1, 11.4.4, D3, D12(4)
27.2.1.7	the ball crossing the net outside the crossing space into the opponent's court or touching the antenna on his/her side of the court. <i>USAV 27.2.1: When flags are not used, the line judges will perform their functions as shown in Diagram 11, Official Hand Signals 9, 14, 15, 22, and 24.</i>	10.1.1, D5a, D12(4)
27.2.2	At the 1 st referee's request, a line judge must repeat his/her signal.	

28 OFFICIAL SIGNALS

28.1 REFEREES' HAND SIGNALS

The referees must indicate with the official hand signal the reason for their whistle (the nature of the fault whistled or the purpose of the interruption authorized). The signal has to be maintained for a moment and, if it is indicated with one hand, the hand corresponds to the side of the team which has made the fault or the request.

28.2 LINE JUDGES' FLAG SIGNALS

The line judges must indicate with the official flag signal the nature of the fault called, and maintain the signal for a moment.

DIAGRAM 1a: COMPETITION/CONTROL AREA

Relevant Rules: 1, 1.4.5, 1.4.6, 4.2.1, 4.2.3.1, 15.4.4, 19.3.2.7, 21.3.2.1, 21.3.3.1, 23.1, 24.1, 25.1, 26.1

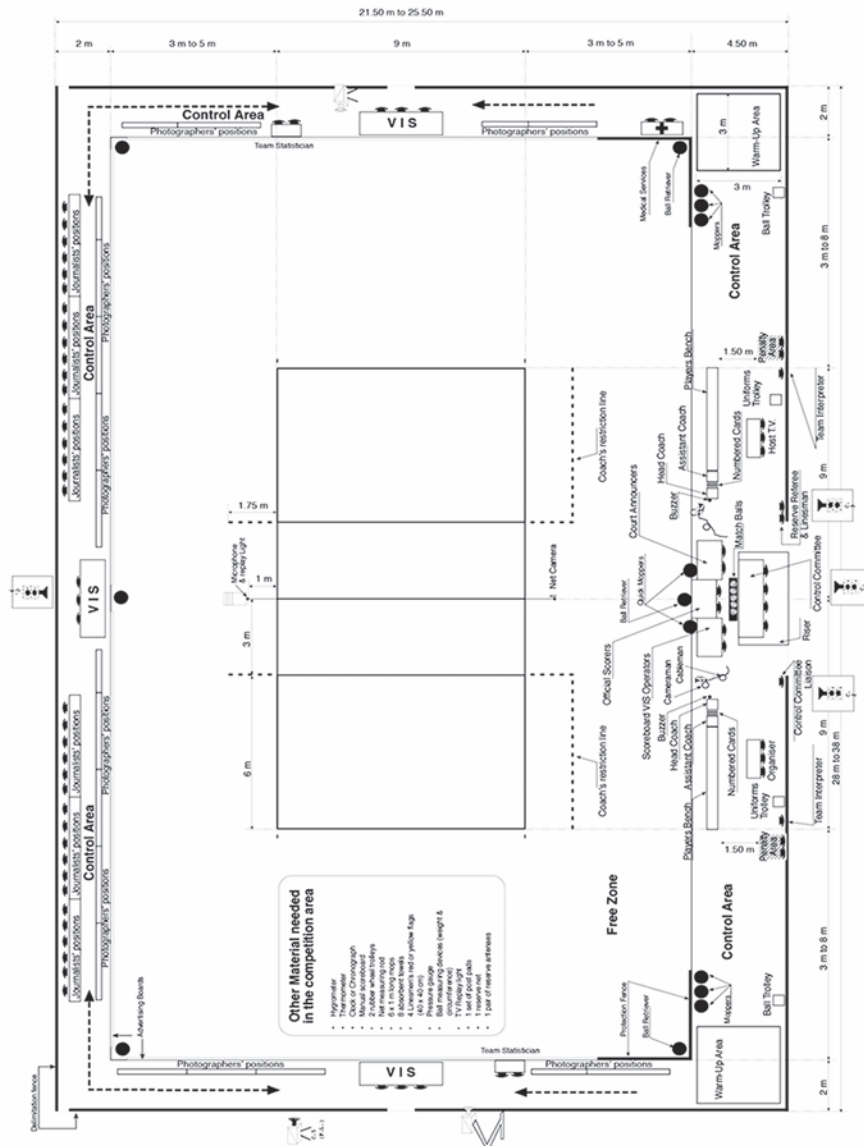

DIAGRAM 1b: THE PLAYING AREA

Relevant Rules: 1, 1.4., 1.4.2, 1.4.3, 1.4.4, 1.4.5, 1.4.6, 4.2.1, 4.2.3.1, 15.10.1, 19.3.1.4, 19.3.2.7, 21.3.2.1

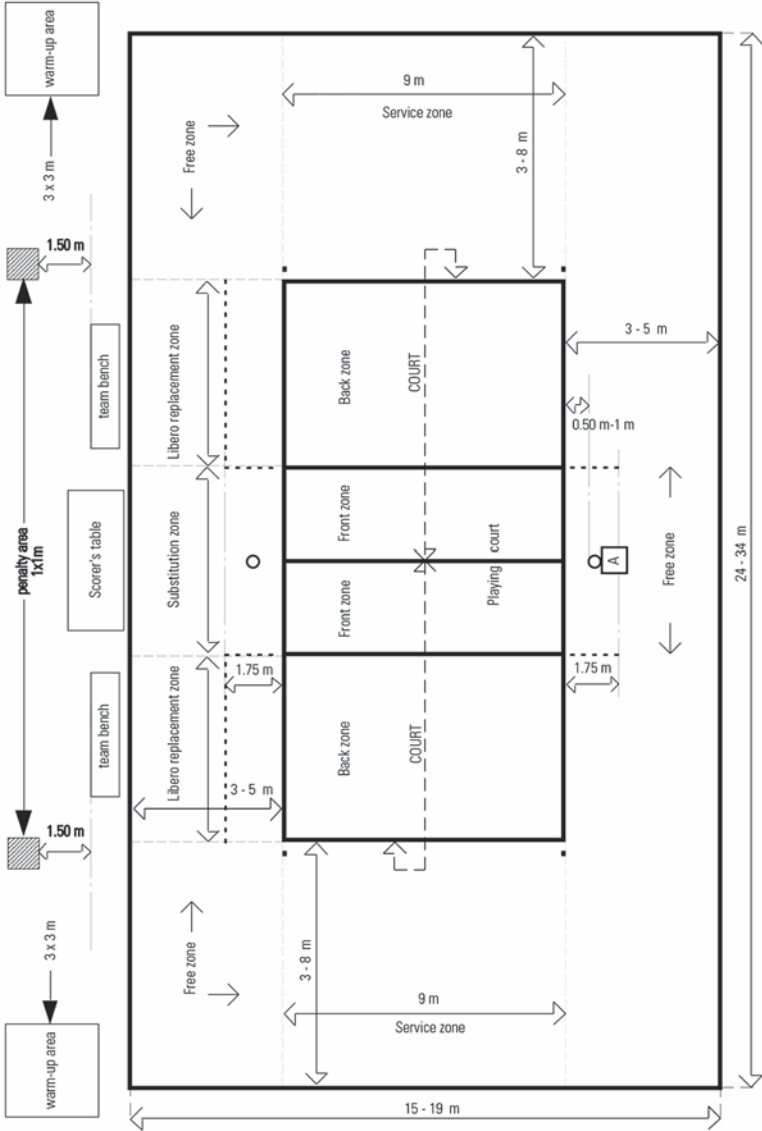

DIAGRAM 2: THE PLAYING COURT

Relevant Rules: 1.1, 1.3, 1.3.3, 1.3.4, 1.4.1, 5.2.3.4

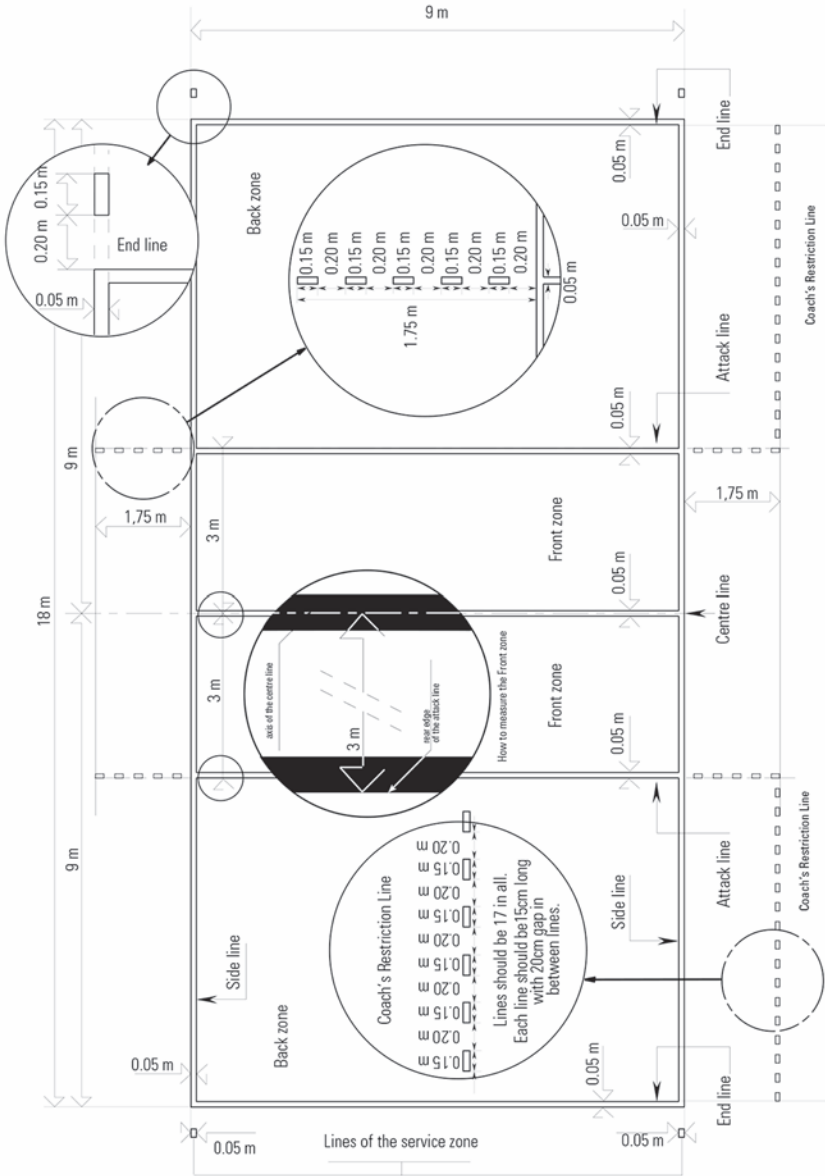

DIAGRAM 3: DESIGN OF THE NET

Relevant Rules: 2, 2.1.6, 2.2, 2.3, 2.4, 2.5.1, 11.3.1, 11.3.2, 27.2.1.6

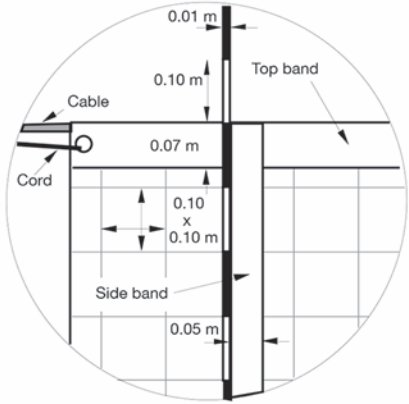
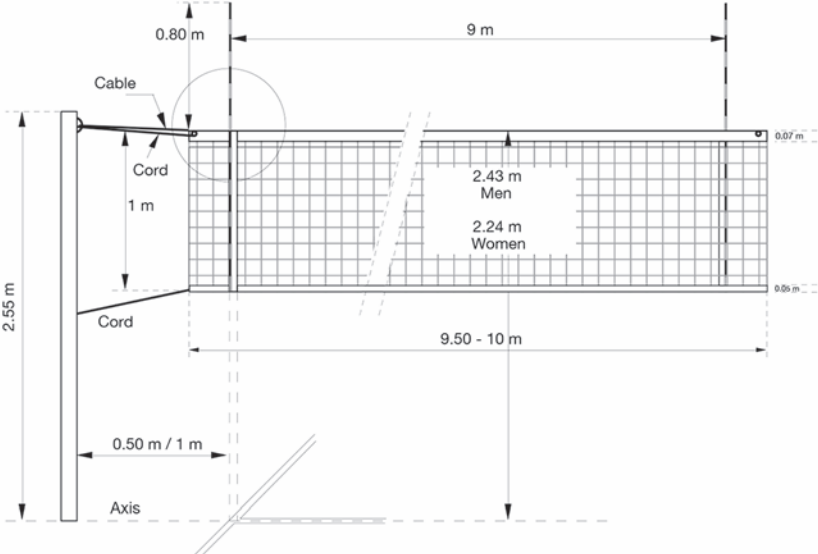
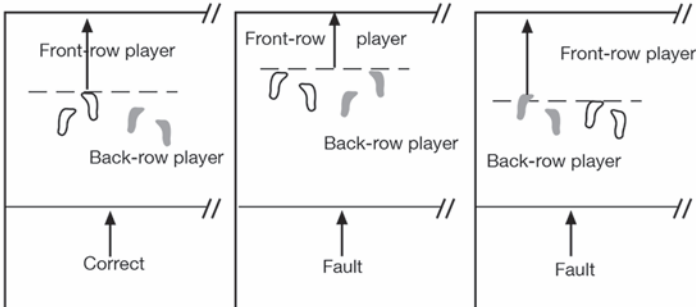

DIAGRAM 4: POSITION OF PLAYERS

Relevant Rules: 7.4, 7.4.3, 7.5, 23.3.2.3a, 24.3.2.2

Example A:

Determination of the positions between a front-row player and the corresponding back-row player



Example B:

Determination of the positions between players of the same row

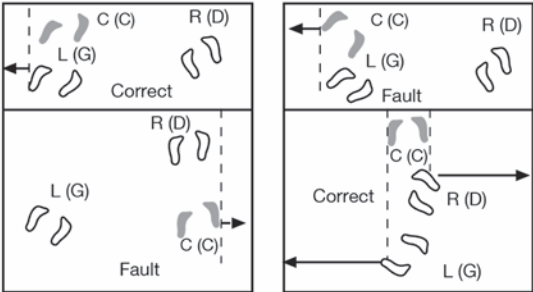

C (C) = Centre player
 R (D) = Right player
 L (G) = Left player

DIAGRAM 5a: BALL CROSSING THE VERTICAL PLANE OF THE NET TO THE OPPONENT COURT

Relevant Rules: 2.4, 8.4.3, 8.4.4, 8.4.5, 10.1.1, 10.1.3, 24.3.2.7, 27.2.1.3, 27.2.1.7

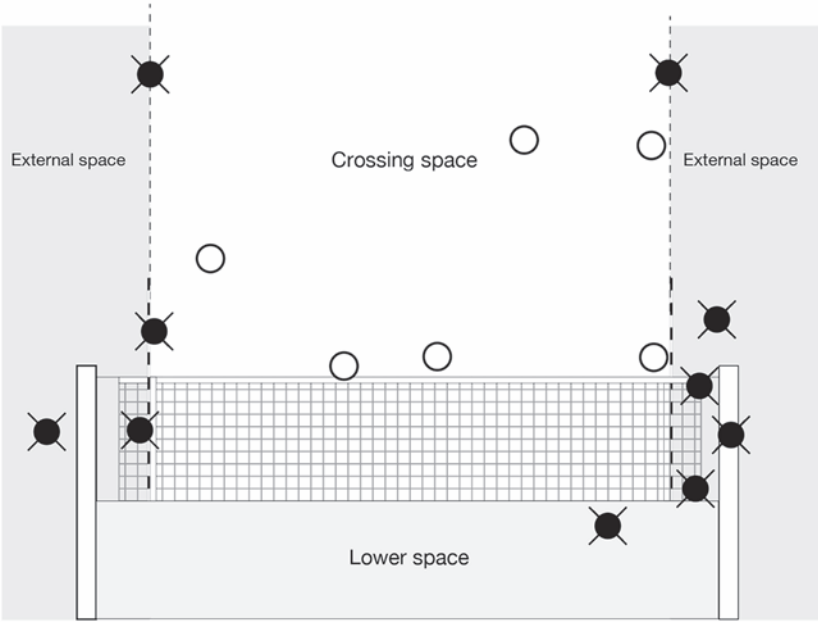

- ⊗ = Fault
- ⊙ = Correct crossing

DIAGRAM 5b: BALL CROSSING THE VERTICAL PLANE OF THE NET TO THE OPPONENT FREE ZONE

Relevant Rules: 10.1.2, 10.1.2.2, 24.3.2.7

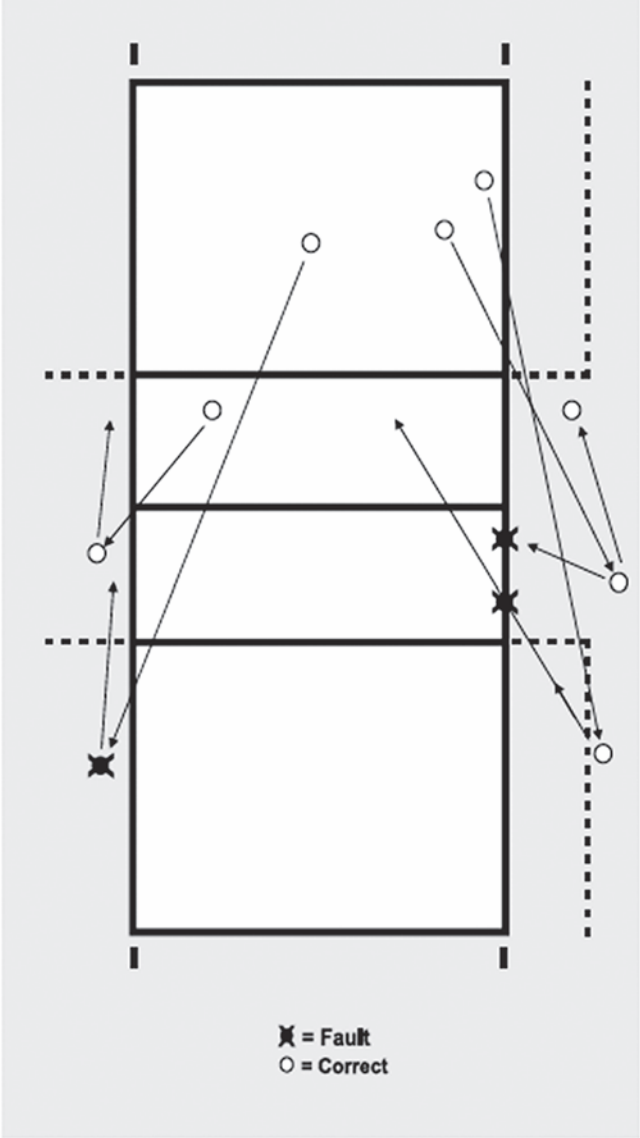

DIAGRAM 6: COLLECTIVE SCREEN

Relevant Rules: 12.5, 12.5.2, 23.3.2.3a

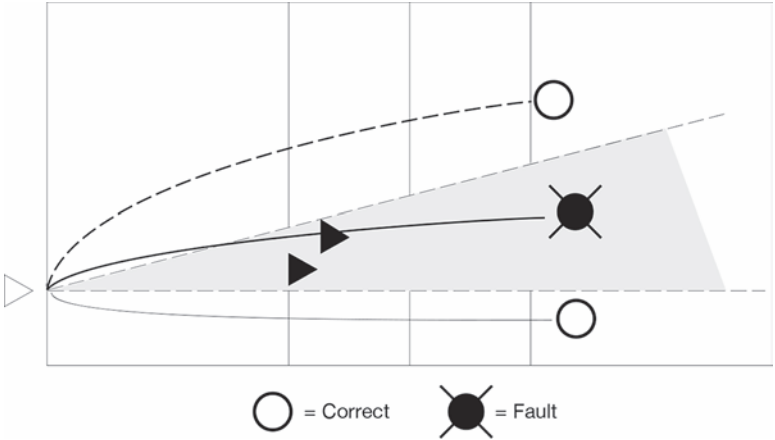

DIAGRAM 7: COMPLETED BLOCK

Relevant Rules: 14.1.3

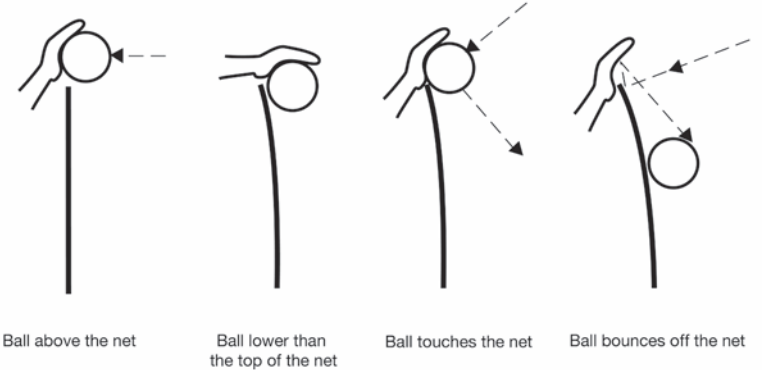

DIAGRAM 8: BACK-ROW PLAYER'S ATTACK

Relevant Rules: 13.2.2, 13.2.3, 23.3.2.3d, 24.3.2.4

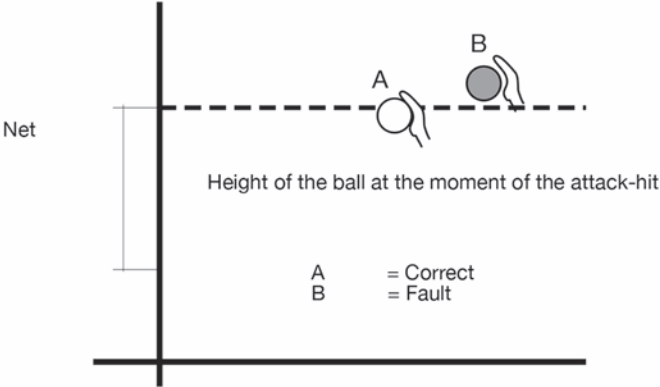
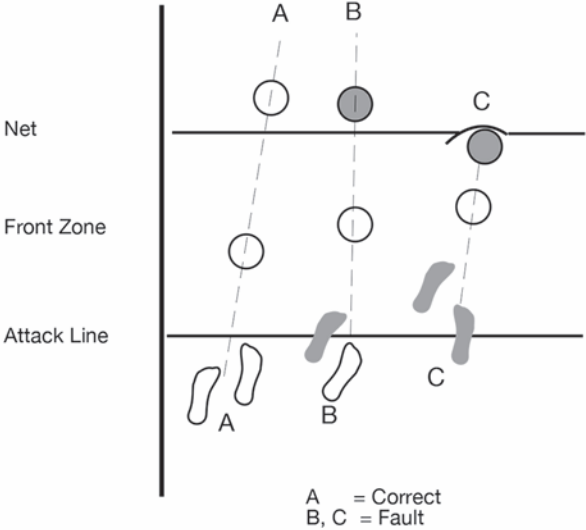

DIAGRAM 9: SANCTIONS SCALE AND CONSEQUENCES

Relevant Rules: 16.2, 21.3, 21.4.2

Note: The application of the yellow card is not a sanction. Sanctions are shown in the table below.

SANCTIONS SCALE AND CONSEQUENCES

CATEGORIES	OCCURRENCE	OFFENDER	SANCTION	CARDS	CONSEQUENCE
RUDE CONDUCT	First	Any member	Penalty	Red	A point and service to the opponent
	Second	Same member	Expulsion	Red + Yellow jointly	Player leaves playing area and stays in the penalty area for the remainder of the set
	Third	Same member	Disqualification	Red + Yellow separately	Player leaves the Competition-Control Area for the remainder of the match
OFFENSIVE CONDUCT	First	Any member	Expulsion	Red + Yellow jointly	Player leaves the playing area and stays in the penalty area for the remainder of the set
	Second	Same member	Disqualification	Red + Yellow separately	Player leaves the Competition-Control Area for the remainder of the match
AGGRESSION	First	Any member	Disqualification	Red + Yellow separately	Player leaves the Competition-Control Area for the remainder of the match

DELAY WARNING SYMBOLS AND SANCTIONS

CATEGORIES	OCCURRENCE	OFFENDER	DETERRENT or SANCTION	CARDS	CONSEQUENCE
DELAY	First	Any member of the team	Delay Warning	Hand signal No. 25 with Yellow card	Prevention – no penalty
	Second and subsequent	Any member of the team	Delay Penalty	Hand signal No. 25 with Red card	A point and service to the opponent

DIAGRAM 10: LOCATION OF REFEREEING CORPS AND THEIR ASSISTANTS

Relevant Rules: 3.3, 23.1, 24.1, 25.1, 26.1, 27.1

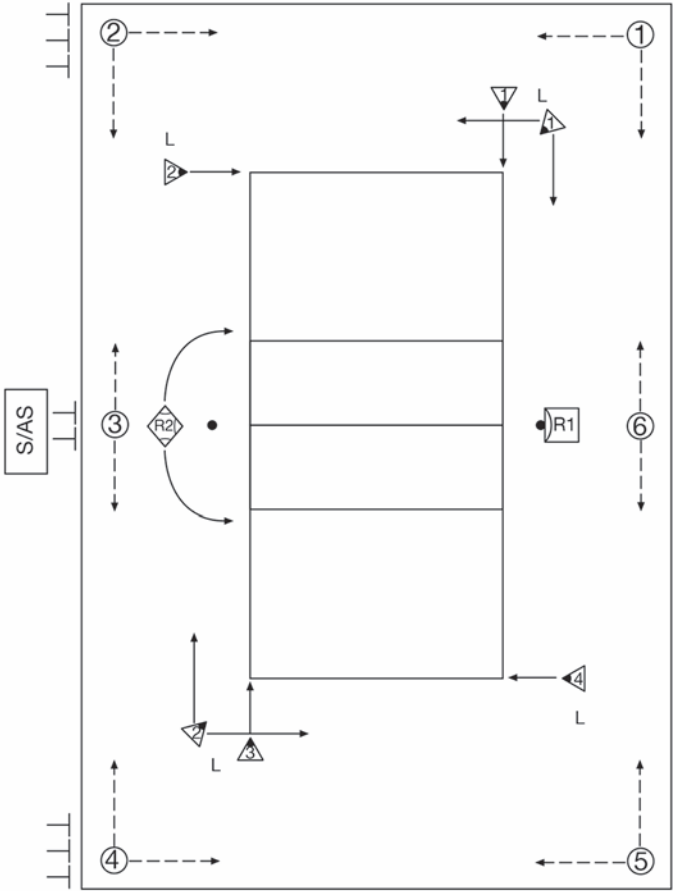



- R1 = First Referee
- ◆ R2 = Second Referee
- S/AS = Scorer/Assistant Scorer
- ▶ L = Lines Judges (numbers 1-4 or 1-2)
- ④ = Ball Retrievers (numbers 1-6)
- = Floor Moppers



DIAGRAM 11: REFEREES' OFFICIAL HAND SIGNALS

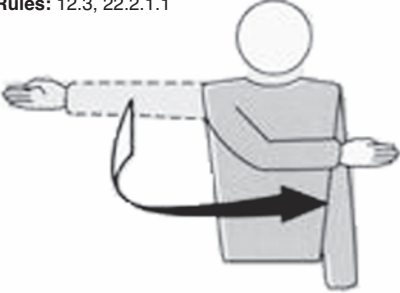
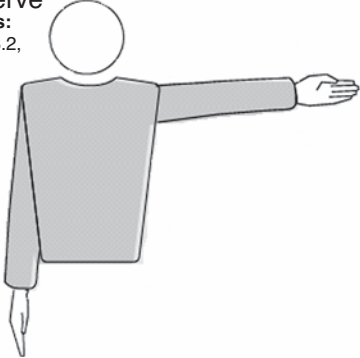
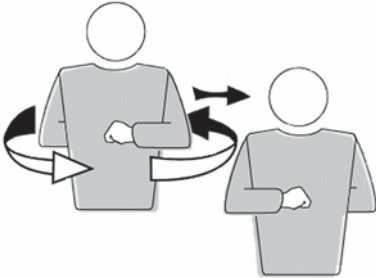

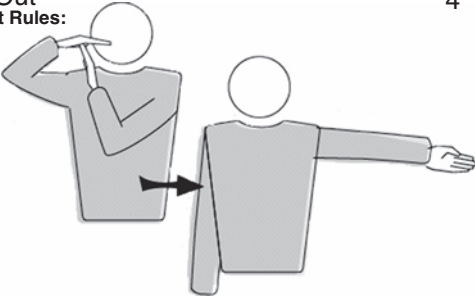
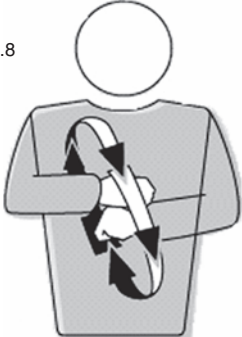
1. All signals which are made with one hand shall be made with the hand on the side of the team that commits the fault or makes the request.



2. After the signal is made, the referee gestures to the player who has committed the fault or the team that has made the request.

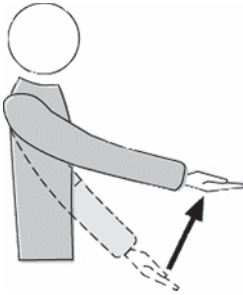
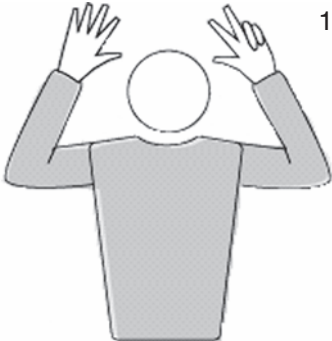

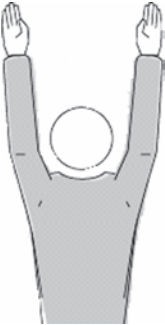
<p>Authorization to Serve Relevant Rules: 12.3, 22.2.1.1</p> 	1	<p>Move the hand to indicate the direction of service.</p>				
<p>Team to Serve Relevant Rules: 22.2.3.1, 22.2.3.2, 22.2.3.4</p> 	2	<p>Extend the arm to the side of the team that will serve.</p>	F			
<p>Change of Courts Relevant Rules: 18.2</p> 	3	<p>Raise the forearms front and back and twist them around the body.</p>	F			

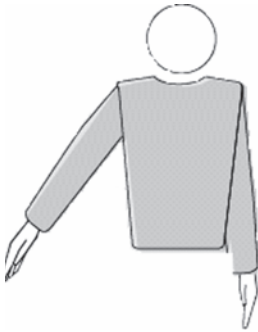
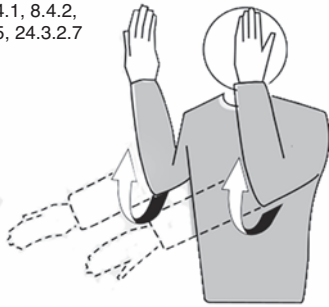
<p>Time-Out Relevant Rules: 15.4.1</p> 	4	<p>Place the palm of one hand over the fingers of the other, held vertically (forming a "T") and then indicate the requesting team.</p>				
<p>Substitution Relevant Rules: 15.5.1, 15.5.2, 15.8</p> 		<p>5</p> <p>Circular motion of the forearms around each other.</p>				
<p>Misconduct Warning Misconduct Penalty 6b Relevant Rules: 21.1, 21.6, 21.3.1, 21.6, 23.3.2.2</p> 	6a	<p>Show a yellow card for warning.</p> <p>Show a red card for penalty.</p>				
<p>Expulsion Relevant Rules: 21.3.2, 21.6, 23.3.2.2</p> 	7	<p>Show both cards jointly for expulsion.</p>				
<table border="1"> <tr> <td>F</td> <td>S</td> <td></td> <td></td> </tr> </table>		F	S			
F	S					
<table border="1"> <tr> <td>F</td> <td>S</td> <td></td> <td></td> </tr> </table>		F	S			
F	S					
<table border="1"> <tr> <td>F</td> <td></td> <td></td> <td></td> </tr> </table>		F				
F						
<table border="1"> <tr> <td>F</td> <td></td> <td></td> <td></td> </tr> </table>		F				
F						

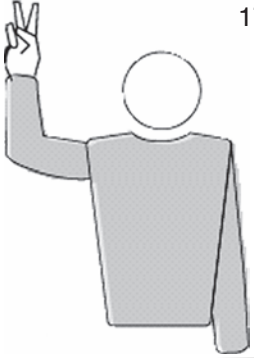
<p>Disqualification Relevant Rules: 21.3.3, 21.6, 23.3.2.2</p> 	8	<p>Show red and yellow cards separately for disqualification.</p>
<p>End of Set (or Match) Relevant Rules: 6.2, 6.3</p> 	9	<p>Cross the forearms in front of the chest, hands open.</p>
<p>Ball Not Tossed or Released at the Service Hit Relevant Rules: 12.4.1</p> <p>Authorization to enter (given to a substitute)</p> 	10	<p>Lift the extended arm, the palm of the hand facing upwards.</p>
<p>Delay in Service Relevant Rules: 12.4.4</p> 	11	<p>Raise eight fingers, spread open.</p>

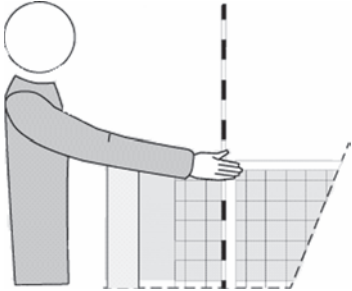
<p>Blocking Fault or Screening Relevant Rules: 12.5, 12.6.2.3, 14.6.3, 19.3.1.3, 23.3.2.3a, g, 24.3.2.4</p>		12	<p>Raise both arms vertically, palms forward.</p>	F	S		
<p>Positional or Rotational Fault Relevant Rules: 7.5, 7.7, 23.3.2.3a, 24.3.2.2</p>		13	<p>Make a circular motion with the forefinger.</p>	F	S		
<p>Ball "In" Relevant Rules: 8.3</p>		14	<p>Point the arm and the fingers toward the floor.</p>	F	S		
<p>Ball "Out" Relevant Rules: 8.4.1, 8.4.2, 8.4.3, 8.4.4, 24.3.2.5, 24.3.2.7</p>		15	<p>Raise the forearms vertically, hands open, palms toward the body.</p>	F	S		

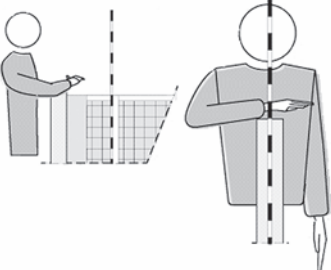
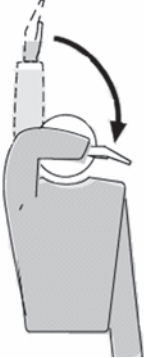
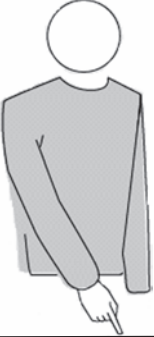
<p>Catch Relevant Rules: 9.2.2, 9.3.3, 23.3.2.3b</p> 	<p>16</p> <p>Slowly lift the forearm, palm of the hand facing upwards.</p> <table border="1" data-bbox="691 399 965 458"> <tr> <td>F</td> <td></td> <td></td> <td></td> </tr> </table>	F			
F					
<p>Double Contact Relevant Rules: 9.3.4, 23.3.2.3b</p> 	<p>17</p> <p>Raise two fingers, spread open.</p> <table border="1" data-bbox="691 761 965 824"> <tr> <td>F</td> <td></td> <td></td> <td></td> </tr> </table>	F			
F					
<p>Four Hits Relevant Rules: 9.3.1, 23.3.2.3b</p> 	<p>18</p> <p>Raise four fingers, spread open.</p> <table border="1" data-bbox="691 1118 965 1181"> <tr> <td>F</td> <td></td> <td></td> <td></td> </tr> </table>	F			
F					
<p>(1) Net Touched by Player (2) Served Ball Fails to Pass to the Opponent Through Crossing Space Relevant Rules: 11.4.4, 12.6.2.1</p> 	<p>19</p> <p>Indicate the relevant side of the net with the corresponding hand.</p> <table border="1" data-bbox="691 1475 965 1532"> <tr> <td>F</td> <td>S</td> <td></td> <td></td> </tr> </table>	F	S		
F	S				

<p>Reaching Beyond the Net 20</p> <p>Relevant Rules: 11.4.1, 13.3.1, 14.3, 14.6.1, 23.3.2.3c</p> 	<p>Place a hand above the net, palm facing downwards.</p> <table border="1" data-bbox="689 399 969 458"> <tr> <td>F</td> <td></td> <td></td> <td></td> </tr> </table>	F			
F					
<p>Attack Hit Fault 21</p> <p>—by a back-row player, by a libero or on the opponent’s service</p> <p>Relevant Rules: 13.3.3, 13.3.4, 13.3.5, 23.3.2.3d, e, 24.3.2.4</p> <p>—on an overhand finger pass by the libero in his/her front zone or its extension</p> <p>Relevant Rules: 13.3.6</p> 	<p>Make a downward motion with the forearm, hand open.</p> <table border="1" data-bbox="689 761 969 824"> <tr> <td>F</td> <td>S</td> <td></td> <td></td> </tr> </table>	F	S		
F	S				
<p>Penetration into the Opponent Court Ball Crossing the Lower Space or the Server Touches the Court (End Line) or the Player Steps Outside His/Her Court at the Moment of the Service Hit 22</p> 	<p>Point to the center line or to the relevant line.</p> <table border="1" data-bbox="689 1118 969 1181"> <tr> <td>F</td> <td>S</td> <td></td> <td></td> </tr> </table>	F	S		
F	S				
<p>Double Fault and Replay 23</p> <p>Relevant Rules: 6.1.2.2, 17.2, 22.2.3.4</p> 	<p>Raise both thumbs vertically.</p> <table border="1" data-bbox="689 1475 969 1533"> <tr> <td>F</td> <td></td> <td></td> <td></td> </tr> </table>	F			
F					



<p>Ball Touched Relevant Rules: 23.3.2.3b, 24.2.2</p> 	<p>24</p> <p>Brush with the palm of one hand the fingers of the other, held vertically.</p> <p><i>USAV: Brush fingers of opposite hand once over palm of vertical hand.</i></p> <table border="1" data-bbox="689 399 971 460"> <tr> <td>F</td> <td>S</td> <td></td> <td></td> </tr> </table>	F	S		
F	S				
<p>Delay Warning/ Delay Penalty Relevant Rules: 15.11.3, 16.2.2, 16.2.3, 23.3.2.2</p> <p>Improper Request</p> 	<p>25</p> <p>Cover the wrist with a yellow card (warning) and with a red card (penalty).</p> <p><u>Without card, hold palm of one hand against the opposite wrist.</u></p> <table border="1" data-bbox="689 761 971 824"> <tr> <td>F</td> <td></td> <td></td> <td></td> </tr> </table>	F			
F					
<p>Illegal contact (used in CO-ED competition)</p> <p>Relevant Rules: Co-ed 1.2, 1.2.1, 1.2.2</p> 	<p>26</p> <p>Place hands together (palms facing each other) overhead.</p> <table border="1" data-bbox="689 1118 971 1182"> <tr> <td>F</td> <td>S</td> <td></td> <td></td> </tr> </table>	F	S		
F	S				

DIAGRAM 12: LINE JUDGES' OFFICIAL FLAG SIGNALS (Indoor)

<p>Ball "In" Relevant Rules: 8.3, 27.2.1.1</p> 	1	<p>Point down with flag.</p>			L
<p>Ball "Out" Relevant Rules: 8.4.1, 27.2.1.1</p> 	2	<p>Raise flag vertically.</p>			L
<p>Ball Touched Relevant Rules: 27.2.1.2</p> 	3	<p>Raise flag and touch the top with the palm of the free hand.</p>			L

<p>Crossing Space Faults, Ball Touched an Outside Object, or Foot Fault by any Player During Service</p> <p>Relevant Rules: 8.4.2, 8.4.3, 8.4.4, 12.4.3, 27.2.1.3, 27.2.1.4, 27.2.1.6, 27.2.1.7</p>	4	<p>Wave flag over the head and point to the antenna or the respective line.</p>								
<p>Judgment Impossible</p>		5								
		<p>Raise and cross both arms and hands in front of the chest.</p>								
		<table border="1" style="width: 100%; height: 100%; border-collapse: collapse;"> <tr> <td style="width: 25%;"></td> <td style="width: 25%;"></td> <td style="width: 25%;"></td> <td style="width: 25%; text-align: center;">L</td> </tr> <tr> <td style="text-align: center;">L</td> <td></td> <td></td> <td></td> </tr> </table>				L	L			
			L							
L										

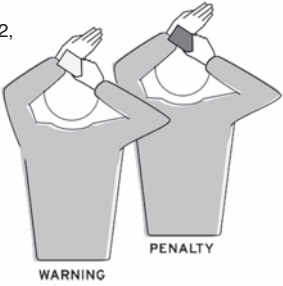
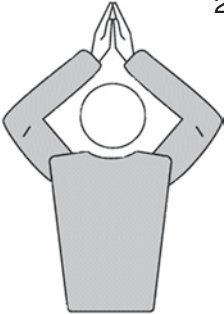

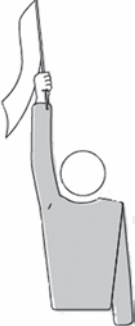
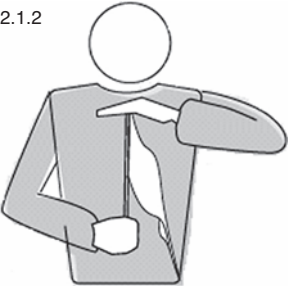
DEFINITIONS

COMPETITION/CONTROL AREA: The Competition/Control Area is a corridor around the playing court and free zone, which includes all spaces up to the outer barriers or delimitation fence. See diagram/fig 1a.

ZONES: These are sections within the playing area (i.e. playing court and free zone) as defined for a specific purpose (or with special restrictions) within the rule text. These include: Front Zone, Service Zone, Substitution Zone, Free Zone, Back Zone, and Libero Replacement Zone.

AREAS: These are sections of the floor OUTSIDE the free zone, identified by the rules as having a specific function. These include: warm-up area and penalty area.

LOWER SPACE: This is the space defined at its upper part by the bottom of the net and the cord joining it to the posts, at the sides by the posts, and the bottom by the playing surface.

CROSSING SPACE: The crossing space is defined by:

- The horizontal band at the top of the net
- The antennae and their extension
- The ceiling

The ball must cross to the opponent's COURT through the crossing space.

EXTERNAL SPACE: The external space is in the vertical plane of the net outside of the crossing and lower spaces.

SUBSTITUTION ZONE: This is the part of the free zone through which substitutions are carried out.

UNLESS BY AGREEMENT OF FIVB: This statement recognizes that while there are regulations on the standards and specification of equipment and facilities, there are occasions when special arrangements can be made by FIVB in order to promote the game of volleyball or to test new conditions.

FIVB STANDARDS: The technical specifications or limits as defined by FIVB to the manufacturers of equipment.

PENALTY AREA: In each half of the competition/control area, there is a Penalty Area located behind the prolongation of the end line, outside the free zone, which should be placed a minimum of 1.5 metres behind the rear edge of the bench.

FAULT: a) A playing action contrary to the rules; b) A rule violation other than a playing action.

DRIBBLING: Dribbling means bouncing the ball (usually as a preparation to tossing and serving). Other preparatory actions could include (amongst others) moving the ball from hand to hand.

TECHNICAL TIME-OUT: This special mandatory time-out is, in addition to time-outs, to allow the promotion of volleyball, analysis of the play and to allow additional commercial opportunities. Technical Time-Outs are mandatory for FIVB, World and Official competitions.

BALL RETRIEVERS: These are personnel whose job it is to maintain the flow of the game by rolling the ball to the server between rallies.

RALLY POINT: This is the system of scoring a point whenever a rally is won.

INTERVAL: The time between sets. The change of courts in the 5th (deciding) set is not to be regarded as an interval.

RE-DESIGNATION: This is the act by which a Libero, who cannot continue or is declared by the team “unable to play,” has his/her role taken by any other player (except the regular replacement player) not on the court at the moment of the re-designation.

REPLACEMENT: This is the act by which a regular player leaves the court and either Libero (if more than one) takes his/her place. This can even include Libero for Libero exchanges. The regular player can then replace either Libero. There must be a completed rally between replacements involving any Libero.

INTERFERING: Any action which will create an advantage against the opponent team or any action which prevents an opponent from playing the ball.

O-2bis: An FIVB official form which registers players and team officials. It should be presented during the Preliminary Inquiry.

OUTSIDE OBJECT: An object or a person which while outside the playing court or close to the limit of the free playing space provides an obstruction to the flight of the ball. For example: overhead lights, the referee’s chair, TV equipment, scorer’s table, and net posts. Outside objects do not include the antennae since they are considered as the part of the net.

SUBSTITUTION: This is the act by which one regular player leaves the court and another regular player takes his/her place.

U-VOLLEY RULES

Height Restrictions

All players shall conform to the height restrictions as prescribed by FIVB rules, which are “under 185 centimeters” (approximately 72.83 inches) for men and “under 175 centimeters” (approximately 68.89 inches) for women.

Height measurement will be in stocking feet or bare feet (without shoes). All players close to this limitation are subject to individual measurement prior to competition during pre-tournament check-in and during random checks throughout the tournament.

USAV: For ease of administration, the height of 6’1” for men and 5’9” for women may be used for recreational play.

CO-ED RULES

The following Rules govern co-ed and reverse co-ed competition. The Rules Commission solicits comments and suggestions from volleyball groups and organizations that conduct and sponsor special competitions such as doubles, triples, mixed doubles, etc.

1. CO-ED PLAY
The Domestic Competition Regulations in general shall govern play for females and males on the same team with the following exceptions:
 - 1.1 The serving order and positions on the court at service shall be male and female alternated or vice-versa.
 - 1.1.1 A team may list two specialized defensive players, “Liberos,” per match or one Libero per set. More information can be found under Rule 19 and USAV 19.1.1.
 - 1.1.1.1 Alternating male and female service order must be maintained. A female Libero may only replace regular female players. A male Libero may only replace regular male players. All other Libero rules and restrictions apply.
 - 1.2 When the ball is played more than once by a team, a female player shall make at least one of the contacts. Contact of the ball during blocking shall not constitute playing the ball. There is no

requirement for a male player to contact the ball, regardless of the number of hits by a team.

1.2.1 If a team contacts the ball more than one time during of-
fensive action, one of the contacts must be by a female
player, but there is no restriction preventing all three
team hits from being made by female players. Contact of
the ball during blocking action does not count as one of
the three team hits. Therefore, after a block, a male
player may play the ball back over the net as such con-
tact would be considered the first team hit.

1.2.2 A ball contacted more than once by a team, without a fe-
male player having contacted it, remains live and does
not become an illegal hit until it fully crosses the plane of
the net or is contacted by an opponent.

1.2.3 An illegally hit ball blocked by an illegal blocker results in
a double fault, and a playover is directed.

1.3 Uniforms of players shall be identical within the following provisions:

1.3.1 All female players shall be attired in identical jerseys and
shorts or one-piece uniforms.

1.3.2 All male players shall be attired in identical jerseys and
shorts or one-piece uniforms.

1.3.3 All uniforms shall be numbered in compliance with USAV
Rule 4.3.3. There shall be no duplicate numbers, regard-
less of color of the jerseys or gender of the player.

1.4 When only one male player is in the front row at service, one
male back-row player may be forward of the attack line for the
purpose of blocking. The remaining back-row player must be be-
hind the attack line until the ball has been contacted by the
blocker(s) or has been hit in such a manner that no block is possible.

1.4 *Commentary: If a back-row player is not participating in a block,
there is no restriction on both back-row male players being in the
attack zone.*

1.4.1 The provisions of Rule 13.2.2 shall govern male back-
row players when playing the ball in other than blocking
actions.

1.4.2 No female back-row player may participate in a block.

1.5 The height of the net for mixed-six play shall be 2.43 m (7'115/8").

1.5.1 Where age group mixed-six competition is conducted,
the height of the net shall be that prescribed for men's
competition in the respective age group. In order to pro-
tect the safety of the competitors, this shall not be modified.

2. REVERSE CO-ED PLAY

The Domestic Competition Regulations as Presented by USAV
in general shall govern play for females and males on the same

- team with the following exceptions:
- 2.1 The serving order and positions on the court at service shall be male and female alternated or vice-versa.
 - 2.2 When the ball is played more than once by a team, a male player shall make at least one of the contacts. Contact of the ball during blocking shall not constitute playing the ball. There is no requirement for a female player to contact the ball, regardless of the number of hits by a team.
 - 2.2.1 If a team contacts the ball more than one time during offensive action, one of the contacts must be by a male player, but there is no restriction preventing all three team hits from being made by male players. Contact of the ball during blocking action does not count as one of the three team hits. Therefore, after a block, a female player may play the ball back over the net as such contact would be considered the first team hit.
 - 2.2.2 A ball contacted more than once by a team, without a male player having contacted it, remains live and does not become an illegal hit until it fully crosses the plane of the net or is contacted by an opponent.
 - 2.3 Uniforms of players shall be identical within the following provisions:
 - 2.3.1 All female players shall be attired in identical jerseys and shorts or one-piece uniforms.
 - 2.3.2 All male players shall be attired in identical jerseys and shorts or one-piece uniforms.
 - 2.3.3 All uniforms shall be numbered in compliance with USAV Rule 4.3.3. There shall be no duplicate numbers, regardless of color of the jerseys or gender of the player.
 - 2.4 When only one female player is in the front row at service, one female back-row player may be forward of the attack line for the purpose of blocking. The remaining female back-row player must be behind the attack line until the ball has been contacted by the blocker(s) or has been hit in such a manner that no block is possible.

2.4 *Commentary: If a back-row player is not participating in a block, there is no restriction on both back-row female players being in the attack zone.*

 - 2.4.1 The provisions of Rule 13.2.2 shall govern female back-row players when playing the ball in other than blocking actions.
 - 2.4.2 No male player may participate in a block.
 - 2.5 Male players may attack the ball from above the height of the net and direct it to enter the opponent's court so long as the ball has an upward trajectory immediately after contact.
 - 2.6 The height of the net for reverse co-ed play shall be 2.24 m (7'4^{1/8"}).

GUIDE TO PHYSICALLY CHALLENGED VOLLEYBALL

From minimal to major disabilities, statistics indicate seven percent of any population is physically challenged. This guide gives you the opportunity to promote volleyball to those with whom you may cross paths who are physically challenged and want to play our great game! Volleyball easily fits with the motto of Disabled Sports/USA: "If I Can Do This, I Can Do Anything."

Along with wheelchair basketball, sitting volleyball has become one of the most widely played and most popular sports in the disabled society. In some parts of the world, the matches are televised. Disabled volleyball is played with participants standing, sitting and in wheelchairs. The sport allows for participation by amputees, as well as cerebral palsy athletes.

We urge you to take the time to teach anyone how to play the sitting version, even if over a rope in a classroom on a night you might have lost the main gym. Please take the time to find those athletes aspiring to play volleyball and join with them in training, either in standing or sitting versions...you'll be amazed.

Volleyball — An Ideal Sport for the Disabled

Volleyball is a team sport which can be played by the physically challenged and able-bodied athletes. It can be played by youth, juniors, adults and seniors in any combination. Unlike many sports, volleyball can be played at all levels co-educationally, creating a gregarious and integrating atmosphere that is appreciated by all involved.

Volleyball is a uniquely universal sport, as it includes persons of minor disability, as well as people who are more severely disabled. Top international sitting teams use setters who are double-leg amputees and these athletes are much faster in on-court movement.

Volleyball practice is economical, especially for sitting volleyball, since no expensive prostheses, wheelchairs and special sport equipment are needed. All that is needed is floor space, a rope or net, and a ball.

Disabled Volleyball History

The need for physically challenged people to compete in sport arose during and after World War II. The rehabilitation process for disabled veterans progressed at a quicker pace when a sporting activity was involved in stimulating recovery. After the war, sitting volleyball was invented in The Netherlands. The first competitive international match was played in 1957.

Disabled Sports/USA (DS/USA), founded in 1976, is the national organization chartered to provide access to year-round, grassroots sports and

recreational programs for children and adults with disabilities. The organization supports the vertical integration of disabled athletes into the National Governing Bodies (NGBs) of the United States Paralympics (USP) on an equivalent basis. The USP was formed in 2001 as part of the U.S. Olympic Committee (USOC) and works with USA Volleyball (USAV) in the development and training of the USA Women's and Men's National Sitting Teams for international World Championships and the Paralympics.

Volleyball's international governing body for physically challenged athletes is World ParaVolley (WPV). WPV oversees international championships and tournaments worldwide to include zonal championships, Intercontinental Cup, World Championships and the Paralympic Games. For more information, log onto www.worldparavolley.org.

Standing Volleyball

Standing volleyball is played by regular volleyball rules with one exception: on-court player rankings of "A", "B" or "C". The six players on court must include a minimum of one "C" class player, and may include a maximum of one "A" class player. If a Libero is on court, the six players must still satisfy this requirement. This is known as a classification system. Players are not classified "A", "B" or "C" by their ability to play, but by the severity of their disability. "A" is considered a minimum disability and "C" would be someone with a more severe disability.

A complete set of rules for standing volleyball can be found and downloaded from the World ParaVolley website at www.worldparavolley.org.

Sitting Volleyball

A complete set of rules for sitting volleyball can be found and downloaded from the World ParaVolley website at www.worldparavolley.org.

The regulation sitting court size is 6 m x 10 m. Boundary lines are included in the court. The centerline divides the court into two courts, 6 m x 5 m each. A racquetball court is almost perfectly sized, especially when using a lowered Wallyball net. The lines of a regular court using two linked nets down the middle allow for three courts (end line to 3-meter line; 3-meter line to 3-meter line; 3-meter line to end line).

Most programs use a normal net that is 1 m wide and 10 m long attached to the standards of a 9 m x 18 m court. (Internationally, a regulation net is 80 cm wide and 6.5 m long). The net height is 1.15 m for men and 1.05 m for women.

The attack lines are drawn parallel to the centerline, 2 m from the middle of the centerline. The service zone is marked with two lines, each 15 cm long and placed inside the service zone at the end of each court, 20 cm behind and perpendicular to the end line. Both are drawn as an extension of each sideline.

The court size and height of the net may be modified for sitting volleyball. Modifications to gym space are acceptable for local play, as long as both courts are equal in size.

Key Rule Modifications for Sitting Volleyball

- The position of each player is determined and controlled by the position of his/her bottom. This means that at the time of service, the hand(s) and/or legs of back-court players may lie in the attack zone, and that the hand(s) and/or legs of on-court players may lie off court.

- “Bottom” is defined as the upper part of the body, from the shoulder to one’s buttocks.

- It is permitted to touch the opponent’s court beyond the centerline with any part of the body provided that it does not interfere with the opponent’s play.

- At all times during playing actions, the players must contact the court with some part of the body between the buttocks and the shoulders, except that a short loss of contact with the court is permitted when playing the ball, excluding the service, the block and attack hit when the ball is completely higher than the top of the net. To stand up, raise the body or take steps is forbidden.

- The back-row player may perform any type of attack-hit from any height, if at the time of the hit the bottom does not touch or cross over to the attack line.

- The referee’s official hand signal of “lifting from the court” is made by raising the upper hand and forearm positioned parallel to the floor and mirror imaging the lower hand and forearm.

- Referees in sitting volleyball must stand to the sides of the court because of the height of the net and the fact that the players are in a seated position.

- Blocking a served ball is allowed.

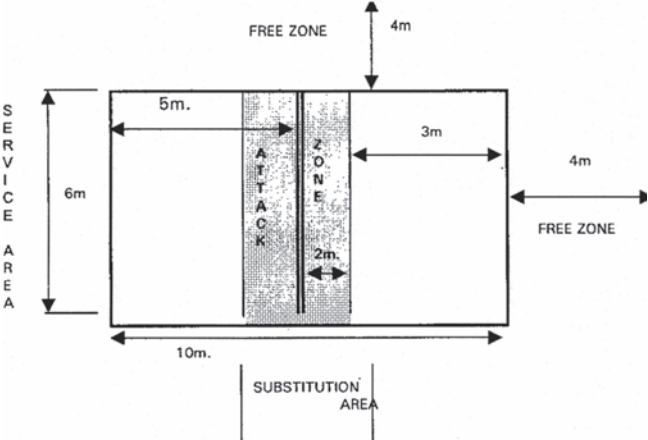

Paralympics

Volleyball has been a Paralympic discipline for more than 20 years. The first Paralympics were conducted in 1960 in Rome, although the expression “The Paralympic Games” was first used in 1984. Although in the beginning it only included men’s competition, women’s sitting volleyball was added to the Athens 2004 Summer Paralympics. In the 2004 Athens Games, the U.S. women’s sitting team earned a bronze medal; and the men, although ending up in sixth place, earned valuable international experience.

The U.S. women’s sitting team won the silver medal at the 2008 and 2012 Paralympics in Beijing, China and London, England. The U.S. men narrowly missed the opportunity to compete in Beijing and London by virtue of a defeat at the hands of Brazil at the 2007 and 2011 Parapan American Games.

The USA needs to identify and train the top American athletes for men’s and women’s sitting and men’s standing volleyball. In 2009, Bill Hamiter was selected as the first high performance director and resident head coach for the U.S. Sitting Teams, which are based at the University of Central Oklahoma (UCO) in Edmond. He will work closely with Elliot Black, the sitting volleyball coordinator at UCO.

USA National Championships

The U.S. Standing Volleyball Team competed in the “A” Division at the 2003 U.S. Open Championships in Minneapolis, Minn. – an event designed for non-disabled athletes. The Sitting Men’s and Women’s Teams also use Nationals and various Junior Qualifiers as training and talent awareness stops on their quadrennial journey to the Paralympics. Sitting volleyball is in its third year as a discipline at the USA Volleyball Open National Championships. At the 2015 event in Detroit, 10 sitting teams participated. There is no requirement that players have to be physically challenged to participate in this division at the USA Volleyball Open National Championships.

Disabled Sports/USA annually holds the National Amputee and Les Autres Games, including the Standing and Sitting Volleyball National Championships. Teams need only three disabled on the roster and two disabled players on the court at all times.

Resources

- If you would like to play, organize or coach a disabled volleyball team, including establishing a volleyball program in your area, please check out www.usavolleyball.org.

- For more information on WPV officiating in the United States, con-

tact Joe Campbell at (713) 702-9516 (cell) or iokepa1@yahoo.com.

•For more information on the sitting team programs at UCO, contact Elliot Blake at (405) 974-3153 or jblake1@uco.com or Bill Hamiter at (405) 974-3138, bill.hamiter@usav.org.

2015-2017 DOMESTIC COMPETITION REGULATIONS (INDOOR) TECHNIQUES, MECHANICS & PROCEDURES

Referee Techniques

1. **Roster verification:** Rosters, if used, are verified pre-match by the scorer, assisted by the 2nd referee. Both referees visually review uniforms for legality.
2. **Coin toss procedures:** USA Volleyball does not designate “home” or “visitor” teams, so the 1st referee will designate a side of the coin for each team during the pre-match and deciding set coin tosses. The coin is tossed and caught, and the result immediately revealed without turning the coin over. If the coin is dropped, it shall be re-tossed. The captain who wins the coin toss has the options of serve or receive the serve, or the side of the court to occupy. The opposing captain then chooses from the remaining options.
3. **Pre-set line-up check 2nd referee:** When checking line-ups at the start of each set, the 2nd referee will stand at the side line of each team’s court with both teams’ line-up sheets in hand to verify player positions. The 2nd referee should not enter the court. The game ball remains at the scorer’s table until line-ups have been verified and Libero replacements authorized. Once the line-up sheets have been returned to the scorer, the game ball is tossed or rolled to the first server.
4. **Referee signal sequence:**
 - a. If the fault is whistled by the 1st referee, the 1st referee indicates which team wins the rally by extending the arm in the direction of the team that will serve next (palm perpendicular to floor), then the nature of the fault and the player at fault, if necessary. All signals are repeated by the 2nd referee except the authorization to serve and a served ball that fails to pass to the opponent through the crossing space.
 - b. If the fault is whistled by the 2nd referee, the 2nd referee indicates the nature of the fault and the player at fault, if necessary. The 1st referee then indicates the next team to serve and the 2nd referee repeats that signal. The 1st referee does not signal the fault or player at fault (Rule 22.2.3.2).

5. **2nd referee position at end of rally:**
 - a. When the 2nd referee's whistle ends a rally, he/she always steps to the offending team's side of the net before signaling the fault.
 - b. When the 1st referee's whistle ends the rally, the 2nd referee will attempt to step to the offending team's side of the net and repeat the signals of the 1st referee. When facilities do not present enough space for the 2nd referee to accomplish this easily, the 2nd referee will simply step laterally away from the post and repeat the 1st referee's signal sequence. NOTE: When the 2nd referee has relevant playing-ending information or is offering discreet assistance, he/she must avoid transitioning and signaling simultaneously, which will result in the information or signal being obstructed by the net post or equipment.
6. **Attack Hit Fault signal (Signal 21):** Completely extend the arm straight up, above the shoulder, hand open, and then bending at the elbow, make a downward motion toward the opposing team. The final position of the arm should not obstruct the referee's view.
7. **Blocking fault/screening signal (Signal 12):** Completely extend both arms straight up from the shoulders (elbows are not bent), palms facing away from the body.
8. **Improper request signal & technique:** An improper request is signaled with a "wave off" – a sweeping motion with the arm extended, open hand, palm facing away from the body, on the offending team's side of the court. The 2nd referee communicates this to the coach at the earliest opportunity, without delaying the match. The 1st referee will signal, at the end of the rally, by placing the palm over the opposite wrist, on the offending team's side of the court. The improper request is recorded on the score sheet at the end of the rally.
9. **Same player makes third and fourth team hits:** Signal "double contact" (Signal 17).
10. **Indication of which player(s) contacted the net:** Indicate the player at fault by pointing toward the player with an open hand.
11. **Completed attack-hit from an overhand set by a Libero in the front zone:** Signal attack hit fault (Signal 21), and then indicate the Libero by pointing toward the Libero with an open hand.
12. **Identification of game captain:** During pre-match line-up checks, the 2nd referee indicates the game captain to the 1st referee by placing the arm in the chest area, hand open and palm facing the floor, and then pointing, open hand, toward this player. This tech-

nique should also be used when the captain is replaced by substitution or the Libero. The captain should acknowledge this designation by raising a hand. It is not necessary for the 2nd referee to repeat this procedure at the start of each set unless the game captain changes or the 1st referee requests the information.

- 13. 2nd referee “ready” signal:** Indicate by holding both hands in front of body, just above head height, palms toward 1st referee. Used by a 2nd referee after any regular game interruption or a delay to the resumption of play. Also used by the scorer upon completion of recording a substitution(s), or at the end of a time-out. “Ready” means that the scorer has recorded all necessary information, the 2nd referee is in proper position, all players have taken their positions on the court, and the 2nd referee is ready for play to resume. The 1st referee is still obligated to complete a court scan, check that the server has the ball, and ensure team readiness before authorizing the next serve.

14. Time-out administration:

- a. 2nd (or 1st) referee whistles to acknowledge time-out request. Both referees make the time-out signal (Signal 4) with the vertical hand of the signal on the side of the requesting team, and point toward the requesting team’s bench with an open hand; 2nd referee will informally display each team’s time-out status to 1st referee at the beginning of the time-out.
- b. Players are not required to leave the court and go to the bench area. Coaches and non-playing team members may not enter the court.
- c. 2nd referee whistles at end of 30 seconds and ensures both teams re-take the court.
- d. Upon conclusion of each team’s second time-out, the 2nd referee will notify the coach (or captain, if necessary) by visually displaying the time-out signal (Signal 4) and then showing two fingers. The 2nd referee will then notify the 1st referee in the same manner after getting into position for the resumption of play and before signaling “ready.”
- e. It is not necessary to notify teams after their first time-out unless requested to do so by the coach/captain. Similarly, the referees do not visually display each team’s time-out status at the end of any time-outs unless necessary for clarification.
- f. Teams may re-take the court prior to expiration of the time-out, unless necessary for the court to remain clear.

- 15. Substitution notification:** With the ninth, 10th, 11th and

12th team substitutions, the 2nd referee will notify the coach by displaying the substitution signal (Signal 5), followed by the number of team substitutions used during the set (10 – clenched right fist, 11 – clenched right fist plus index finger of left hand, 12 – clenched right fist plus index and middle finger of left hand). The 2nd referee will notify the 1st referee of a team's 12th substitution in the same manner after getting into position for the resumption of play and before signaling "ready." If requested by the 1st referee, the 2nd referee will also inform the 1st referee of the ninth, 10th and 11th substitutions in this manner.

- 16. Multiple substitutions by one team:** Only one incoming player may be in the substitution zone at a time awaiting authorization to enter. Subsequent substitutes must wait outside the substitution zone until the first pair of players has been authorized to enter by the 2nd referee. For multiple substitutions by a team during the same dead ball, there can be no significant delay between substitutions.
- 17. Substitution request procedure:** A request for substitution requires that the incoming substitute has entered the substitution zone before the request is acknowledged (whistled). Verbal or hand-signal requests for substitution by the coach or captain do not constitute a formal request and will not be acknowledged (whistled). NOTE: Referees must facilitate this procedure and ensure that teams are educated in its use.
- 18. Requests for game interruption by opponents during same dead ball:** When opponents request a game interruption (time-out, substitution, etc.) during the same dead-ball period, the 2nd referee will acknowledge each team's request with a separate whistle. Multiple substitutions by the same team require only one whistle.
- 19. 1st/2nd referee duties:**
 - a. 1st referee controls player conduct during the pre-match warm-ups. The 1st referee also times the warm-ups but may request the 2nd referee to assist while 1st referee instructs line judges or attends to other pre-match duties.
 - b. Either referee may whistle net faults, and attack-hit or blocking faults.
 - c. 2nd referee calls (whistles) antenna faults on his/her side of the court.
 - d. At the end of the match, the 1st referee checks the score sheet for accuracy, and then signs it.
- 20. 2nd referee discreet assistance techniques:** Discreet assistance from the 2nd referee should only be offered when, from the 2nd referee's view, a fault has occurred. Discreet assistance should not be used for possible faults, e.g., to indicate that no oppos-

ing player touched the ball after a team's third contact.

Expectations regarding these techniques should be the subject of referees' pre-match briefings. NOTE: Discreet signals, which are indicated using only one hand (ex: 2 hits, 4 hits, attack-hit fault, etc.) should be signaled with the hand corresponding to the team at fault. If the view of the 2nd referee is obstructed, the discreet signal may be made with the more visible hand.

- a. 2 hits vs 4 hits: The 2nd referee should use the appropriate discreet assistance only after the same player has hit the ball twice in succession ("2 hits") or after a team has touched the ball four times and the third and fourth hits were not by the same player ("4 hits"). NOTE: "4 hits" should not be used to indicate "no touch" by the blocking team.
- b. Attack-hit fault: The attack fault signal (Signal 21) should be shown in the chest area, and the 2nd referee should allow the 1st referee the opportunity to whistle the fault or to communicate that the play was legal before whistling this fault (USAV 24.3.2.4).
- c. Blocking fault: The 2nd referee may whistle this fault immediately, or a discreet blocking fault signal (Signal 12) may be shown in the chest area with hands only, shoulder-height.
- d. Requesting an individual sanction: The 2nd referee should whistle, step to the offending team's side of the court, and verbalize the sanction and offending team member. Other hand signals are not necessary to request an individual sanction.
- e. Requesting a delay sanction: Display the delay sanction signal, without a card in chest area.
- f. Ball in/pancake play: Step to the side of the court where the ball hit the floor, maintain a position visible to the 1st referee, and give the "ball in" signal. If the 1st referee does not see this assistance, the signal should be made more visible. If the 1st referee does not quickly recognize the assistance, the 2nd referee should whistle this fault.
- g. Ball handling opinions: The 2nd referee should not offer ball handling opinions during a match. Only if the 1st referee has requested such assistance during unusual plays (i.e., the 1st referee is screened from viewing the play) should the 2nd referee offer an opinion.
- h. Touch information: At the end of a rally in which the 2nd referee has observed a player touching the ball before it lands out of bounds, the 2nd referee should offer a visi-

ble “touch” signal (Signal 24). If the 1st referee does not notice this assistance, the signal should quickly be made more visible and the 2nd referee should step laterally, away from the post.

- 21. Deciding set coin toss:** For the deciding set coin toss, the 1st referee conducts the coin toss near the scorer’s table or may request the 2nd referee to do so. During this time, teams are released to their benches while each team’s game captain attends the toss. The coin toss takes place during the three-minute interval between sets. After the coin toss, the 1st referee will blow a whistle to direct teams to change courts or to remain at their current benches for the start of the deciding set; the scorer will be immediately notified of the result in order to prepare the deciding set score sheet; and, if the 1st referee conducted the toss, the 1st referee will immediately return to the stand.
- 22. Change of courts during deciding set:** The 1st referee will signal for teams to change courts immediately after the eighth point has been scored by a team. Teams are not directed to the end lines during this court change but they should change sides by going counter-clockwise around the post to their respective right side (or under the net near the sideline if space does not permit the players to pass outside the posts). To prevent teams from crossing under the net in the middle of the court, the 2nd referee will enter the court to his/her right and direct the team on the right to change sides as described above. The 2nd referee will also ensure the team on the left changes sides accordingly. The 2nd referee will return to the scorer’s table after the court change to ensure the scorer is ready to resume, and may confirm each team’s court positions before continuing.
- 23. Set/Match point:** The 2nd referee will verbally/visually confirm set or match point with the scorer and then place an index finger against the shoulder corresponding to that team. For example, if the team to the 2nd referee’s left has earned set/match point, the index finger of the right hand will be placed against the left shoulder (or vice versa for the team on the right).
- 24. Ball hitting an antenna:** When the ball is hit into an antenna, the referee will whistle and signal “out,” and if necessary, will indicate with an open hand the player who hit the ball into the antenna. The referee does not point toward the antenna before or after signaling “out” for the antenna fault. If the 1st referee whistles the antenna fault, he/she will first show the team to serve next before signaling the antenna fault.
- 25. First referee whistling positional faults on receiving team:** The 1st referee will normally check position faults for the serving team only; the 2nd referee is authorized to check posi-

tion faults for receiving team only. If the 2nd referee does not call a blatant positional fault after ample communication/ notification by the 1st referee, the 1st referee may whistle this fault. This will occur only on very rare occasions.

26. Sanction procedures:

- a. For a player on court: The player being sanctioned must approach the 1st referee's stand to acknowledge the sanction. In the case of a penalty, the 1st referee will first award a point to the team to serve next, display the appropriate card(s) to the sanctioned player, and then verbalizes, "This penalty (or expulsion or disqualification) is for you for unsporting conduct."
- b. For a team member on the bench: The 1st referee will call the game captain to the stand. In the case of a penalty, the 1st referee will first award a point to the team to serve next, display the appropriate card(s), and verbalize, "This penalty (or expulsion or disqualification) is for player (or coach) 'X'. Please inform him/her of the sanction." The captain should go immediately to the bench to inform the team member, who will acknowledge the sanction while the 1st referee continues to display the card(s).
- c. For delay sanctions: The 1st referee will call the game captain to the stand, indicate the team to serve next if in the case of a delay penalty, and verbalize "This delay sanction is for [delay action]," while displaying the appropriate signal. The captain may inform the coach of the sanction for clarification purposes.
- d. For verbal (official) warnings: Verbal or hand signal warnings must be accompanied by a whistle and are notified directly to the team member being warned or through the game captain. Multiple warnings to the same team member during the same set/match are permitted for minor unsporting conduct.
- e. For simultaneous sanctions to opponents: When individual sanctions are assessed to opponents for simultaneous unsporting acts, the team member from the serving team shall be sanctioned first, followed by the team member from the receiving team. The sanctions are administered following the above procedures.

27. Notification of illegal Libero replacement: The assistant scorer shall notify the 2nd referee of an illegal Libero replacement after the contact of the serve. A positional fault is the resulting fault.

28. Line judge position during time-outs:

At midpoint of respective end line.

- 29. Line judge position when server is within 1-2 meters of the line judge:** When a server takes a position within 1-2 meters of the line judge, the line judge must step behind the server along the sideline extension. When space prohibits stepping behind the server, it is appropriate to stand along the end-line extension. After the service contact, the line judge should quickly return to the position at the intersection of the end line and sideline.

Points of Emphasis

1. Warm-ups:

- a. For adult competition: When one team has exclusive use of the court, the opposing team may warm up with practice balls in the free zone surrounding the court but may not interfere with the warm-up of the opponent on the court, including serving practice.
- b. For junior competition: When one team has exclusive use of the court, the other team must either be at its team bench or out of the playing area. The team may also retrieve balls for the opposing team. Warming up with balls at the team bench or the spectator walkways is not permitted.

- 2. The Serve:** The server must be on the playing surface before the serve is authorized. The entire service action must take place on the playing surface.

3. Coaches' Location:

- a. All coaches must remain 1.75 meters (5'10") from the court while the ball is in play. During dead-ball periods, coaches may briefly approach the court to give instructions to players on the court but must step away from the court when the 1st referee prepares to authorize the service. If a coach fails to adhere to this rule after being reminded to do so, a delay sanction may be assessed. NOTE: When the distance between the sideline and the team bench/bench area is less than 2 meters, the coach must remain in the free zone nearer to the team bench/bench area while the ball is in play. Coaches may not enter the substitution zone.
- b. The coach or one assistant coach may give instructions to a player in the warm-up area but may not remain there for any extended length of time.

- 4. Assistant Coaches:** One assistant coach at a time may leave the bench to give instructions to the players on the court. During play, this assistant coach may give these instructions

while standing or walking within the free zone in front of his/her team's bench from the extension of the attack line up to the warm-up area, no closer to the court than 1.75 meters (5'10") from the sideline and its extension, without disturbing or delaying the match. Assistant coaches may not address the referees.

5. Disruptive Coaching: Includes loud or abusive language, comments to officials or to opposing teams, throwing of objects, and displaying disgust in an overt manner.

6. The Libero:

- a. Up to two Liberos may be designated on the line-up sheet at the start of the match. If zero or one Libero is designated on the line-up sheet, the coach may select a different Libero for subsequent sets, but may not have two Liberos. If two Liberos are designated on the line-up sheet for Set 1, those are the only two Liberos who may play for that team for the match.
- b. The Libero's jersey or jacket must contrast in color to the color of the jersey worn by other members of the team. (Please note USAV 19.2a.) The Libero jerseys do not have to match, but they must both be contrasting from the other members of the team.
- c. If a Libero wears an exposed undergarment as noted in USAV 4.3, that undergarment may differ from exposed undergarments worn by teammates.
- d. A Libero may replace an injured player in the back row after the 30-second injury evaluation if no Libero was on the court at the time of the injury.
- e. Only one Libero per team may be on the court in replacement of a teammate at any given time.

7. Player Equipment:

- a. If a player's towel falls to the floor during a rally, which consequently requires a stoppage of play, a delay sanction must be issued. The rally should not be stopped unless a referee judges that a safety hazard exists. A delay sanction can be avoided if the team takes steps to mitigate the risk hazard in this situation.
- b. Player equipment (eyeglasses, contact lenses, etc.) is worn at the player's own risk (Rule 4.5.2). If a stoppage of play results due to a concern for safety, a delay sanction is assessed and a replay will be granted. A similar rationale, as noted above in 7a, should be used to determine if a safety hazard exists. If a player is injured as his/her lenses fall to the floor, the injury takes precedence and the provisions of Rule 7.1 should be applied.
- c. Casts are not permitted, regardless of covering or padding.

- d. Bobby pins, barrettes and hard plastic headbands may be used to control the hair. Such items do not need to be covered or padded.
- e. For adult competition, jewelry may be worn provided its nature does not present a concern for safety, e.g., extremely long necklaces and/or necklaces with large medallions, or large hoop earrings.

8. Interference with Play:

- a. A player who places a hand/hands near the net in the path of a ball to deflect the natural rebound of a ball that has been passed into the net by the opponent has committed a net fault according to the FIVB/USAV interpretation of “interferes with play.”
- b. If a player contacts an official (2nd referee or line judge) during an attempt to play the ball legally, the 1st referee may award a replay if the physical interference impeded that player’s attempt.
- c. A ball that contacts an official (referee or line judge) is ruled “out” per Rule 8.4.2.

9. Improper Requests (See also Referee Techniques #8):

- a. A request for an illegal substitution shall result in an improper request. However, if such a request is acknowledged (i.e., whistled), a delay sanction shall result.
- b. Despite any previous delay sanction, a team’s first improper request of the match is rejected, and the improper request is assessed without further sanction.

10. Line-up Checks: A line-up check is not considered a regular game interruption and is permitted prior to re-authorizing the serve for a rally that was not completed. A line-up check may not be requested after the service authorization, and before the service contact, even if the 1st referee must authorize the serve a second time due to external interference (e.g., a ball on the court). Coaches or captains may request a line-up check.

2015-2017 INSTRUCTIONS FOR SCORERS USING THE OFFICIAL INDOOR SCORE SHEETS

Diagram 1

		Name of the Competition _____	
City, State _____		HEADINGS	
Hall _____		Division <input type="checkbox"/> Men <input type="checkbox"/> Women <input type="checkbox"/> Cadet <input type="checkbox"/> (INK) <input type="checkbox"/> Level _____	
Category <input type="checkbox"/> Adult <input type="checkbox"/> Junior <input type="checkbox"/>		vs	
Date _____		8:00a = 08:00	
Court _____		1:00p = 13:00	
Time _____		2:00p = 14:00	
		3:00p = 15:00	
D-Duty Asst Coach IMPROPER REQUEST		RESULTS	
E-Coach Manager TEAM (A) : TEAM (B)		TEAM SET RESULTS Score	
W P E D (A) SET SCORE		Winning (INK)	
WarmPenaltyExptl Disq (B) SCORE		Losing (INK)	
SANCTIONS		SIGNATURES	
REMARKS		Scorer (INK)	
		1st Referee (INK)	
		OFFICIALS PRINTED NAMES	
		1st 1st 2nd 2nd Scorer Scorer Work team Region	
REMARKS		OFFICIALS (INK)	

CAPTAIN		CAPTAIN	
TEAM INFO		TEAM INFO	
Order		Set	
I II III IV V VI		I II III IV V VI	
SERVICE ORDER		SERVICE ORDER	
Points		Points	
1 13 25		1 13 25	
2 14 26		2 14 26	
3 15 27		3 15 27	
4 16 28		4 16 28	
5 POINTS		5 POINTS	
6 18 20		6 18 20	
7 19 31		7 19 31	
SCORE at		SCORE at	
8 20 32		8 20 32	
9 21 33		9 21 33	
10 22 34		10 22 34	
11 23 35		11 23 35	
12 24 36		12 24 36	
SUBSTITUTION		SUBSTITUTION	
1 4 1 4 1 4 1 4 1 4		1 4 1 4 1 4 1 4 1 4	
2 5 2 5 2 5 2 5 2 5		2 5 2 5 2 5 2 5 2 5	
SERVICE ROUNDS		SERVICE ROUNDS	
3 6 3 6 3 6 3 6 3 6		3 6 3 6 3 6 3 6 3 6	
4 7 4 7 4 7 4 7 4 7		4 7 4 7 4 7 4 7 4 7	
5 8 5 8 5 8 5 8 5 8		5 8 5 8 5 8 5 8 5 8	
6 9 6 9 6 9 6 9 6 9		6 9 6 9 6 9 6 9 6 9	
7 10 7 10 7 10 7 10 7 10		7 10 7 10 7 10 7 10 7 10	
8 11 8 11 8 11 8 11 8 11		8 11 8 11 8 11 8 11 8 11	
9 12 9 12 9 12 9 12 9 12		9 12 9 12 9 12 9 12 9 12	
10 1 10 1 10 1 10 1 10 1		10 1 10 1 10 1 10 1 10 1	
11 2 11 2 11 2 11 2 11 2		11 2 11 2 11 2 11 2 11 2	
12 3 12 3 12 3 12 3 12 3		12 3 12 3 12 3 12 3 12 3	
Legal Substitutes		Legal Substitutes	

S1 GENERAL PROCEDURES

S1.1 RECORDING INFORMATION

- S1.1.1 The scorer clearly records all information (except the signatures) using **PRINTED CAPITAL** letters on the score sheet.
- S1.1.2 Some information must be recorded using **blue/black ink**.
 - a. The instructions will indicate if **blue/black ink** is required.
- S1.1.3 Other information may be recorded using either pencil or **blue/black ink**.
- S1.1.4 *National Scorers: Must record all information using blue/black ink.*

S1.2 INCORRECT INFORMATION

- S1.2.1 Incorrect information must be corrected immediately.
- S1.2.2 Remove the incorrect information by:
 - a. Use of correction tape
 - b. Use of an eraser
 - c. Crossing out information using an **X**.

S1.3 DATES

All dates are recorded using **MM/DD/YY** or **MM-DD-YY** with leading zeros as necessary.
Examples: 06/02/15 06-02-15

S1.4 TIMES

All times are recorded using International Time **HH:MM** with leading zeros as necessary.
Examples: 9:10AM=09:10 1:15PM=13:15

S1.5 SCORES

When an action requires recording both team scores (time-outs, substitutions, sanctions, remarks), record the score of the team causing the action first.
Example: Team **A** score **5** and Team **B** score **10** when Team **B** takes a time out. Record **10:5** as score.

S1.6 PENALTY POINTS

- S1.6.1 Slash the point in the **POINTS** column.
- S1.6.2 Draw a circle around the slashed point.

S1.7 AUTOMATIC THREE (3) SET MATCHES

Some events use a best-of-three sets match format with

some matches designated to play all 3 sets (**automatic three (3) set match**).

S1.7.1 If a coin toss and court change is required for Set 3, a deciding set score sheet must be used and the scoring procedures are the same as if it was a deciding set.

S1.7.2 If no coin toss or court change is required for Set 3, a regular score sheet is used and the scoring procedures are the same as for any non-deciding set.

S1.8 READY SIGNAL

S1.8.1 When ready for the set to continue:

- a. Make eye contact with 2nd referee;
- b. Raise both hands, palms toward the court.

S2 PRE-MATCH

S2.1 BEFORE THE START OF A MATCH

S2.1.1 Prepare all the score sheet(s) for the match by recording the match information for:

- a. Sets 1 and 2 for a best-of-three match;
- b. Sets 1 through 3 for an 'automatic 3-set match';
- c. Sets 1 through 3 for a best-of-five match.

S2.2 HEADINGS

Use blue/black ink.

If the heading information is not pre-printed, record the following information:

S2.2.1 **Name of Competition**

S2.2.2 **City, State**

S2.2.3 **Hall** NAME OF FACILITY

S2.2.4 **Pool Phase**

For Pools use number or letter;

For Phase use playoff bracket
(e.g. GOLD, SILVER, BRONZE, etc.);

S2.2.5 **Division** X the appropriate box

S2.2.6 **Match No.** number or SEMI, FINAL, etc.

S2.2.7 **Category** X the appropriate box

S2.2.8 **Level** Record the level of play
(AA, A, 40s, 16O, or other description)

S2.2.9 **vs** Record the complete names of the
playing teams for the match;
TEAM NAME vs TEAM NAME

In the upper right hand corner

- S2.2.10 **Date** Match Date
S2.2.11 **Court** Court Number
S2.2.12 **Time** Scheduled Match Time
Leave blank if the scheduled time is based solely on the previous match's end time.

S2.3 OFFICIALS PRINTED NAMES

Use blue/black ink.

Record all officials' names as LAST NAME, FIRST NAME.

- S2.3.1 **1st** Name of First Referee
S2.3.2 **2nd** Name of Second Referee
S2.3.3 **Scorer** Name of Scorer
S2.3.4 **Work Team** WORK TEAM NAME
S2.3.5 **Region** Region code of work team
(2 character code)

S2.4 SET NUMBER

Use blue/black ink.

If not pre-printed, record the set number in the **Set** box.

S2.5 SET WITH SCORE NOT STARTING AT 0-0

Use blue/black ink.

For any set not starting at 0-0, record the unused points with the **T-Bar** method as follows:

Set starts at 4-4

- S2.5.1 Draw a horizontal line below the last unused number in the **Points** column.

- S2.5.2 Draw a vertical line from the top of the **Points** column to the horizontal line.

Points			Points		
1	13	25	1	13	25
2	14	26	2	14	26
3	15	27	3	15	27
4	16	28	4	16	28
5	17	29	5	17	29

S3 STARTING THE MATCH

S3.1 TEAM DESIGNATION

After the coin toss and the determination of the serving team and the playing area.

- S3.1.1 Designate the team that begins Set 1 on the **left** court as Team **A**.
S3.1.2 Designate the team that begins Set 1 on the **right** court as Team **B**.

- S3.1.3 Each team keeps the **A/B** letter designation assigned in Set 1 for the entire match.

S3.2 TEAM INFORMATION

Use blue/black ink.

S3.2.1 **For Set 1**, in the **TEAM INFO** section:

- a. Record Team **A**'s name (shorten as needed) in the **Team** box on the left side.
 - 1) If not pre-printed, record an **A** in the **A/B** circle on the left side.
- b. Record Team **B**'s name (shorten as needed) in the **Team** box on the right side.
- c. If not pre-printed, record a **B** in the **A/B** circle on the right side.

S3.2.2 **For the remaining non-deciding Sets**, in the **TEAM INFO** section:

- a. Teams will change courts for each non-deciding set.
- b. Record Team Information on the opposite sides from the previous Set score sheet.

For Set 2:

- 1) Record Team **B** information on the left side.
 - 2) Record Team **A** information on the right side.
- c. Alternate for each remaining non-deciding set score sheet.

S3.3 SERVING AND RECEIVING TEAMS

Use blue/black ink.

S3.3.1 For the team serving first:

- a. Record an **X** through the **Ⓢ**.

S3.3.2 For the team receiving first:

- a. Record an **X** through the **Ⓡ**.
- b. Record an **X** in box 1 of the **SERVICE ROUNDS** section for the player in **SERVICE ORDER I**.

S3.3.3 Repeat S3.3 on all non-deciding score sheets. Serve and receive will remain on the same court (side).

S3.4 ROSTERS (IF REQUIRED BY EVENT)

Rosters may not be used by all events.

S3.4.1 Obtain an official roster from each team.

- S3.4.2 Verify player uniform numbers are correct and accurate.
- S3.4.3 Once submitted, no roster changes are permitted unless approved by event management.
- S3.4.4 Roster changes may result in team penalties as directed by event management.

S3.5 TEAM CAPTAINS (FROM ROSTERS)

Use blue/black ink.

- S3.5.1 No Rosters, Record an **X** in the **Captain** box.
- S3.5.2 Rosters with no designated team captain, record an **X** in the **Captain** box.
EXAMPLE: No rosters or
No Team Captain designated

CAPTAIN

X	○										
----------	---	--	--	--	--	--	--	--	--	--	--

- S3.5.3 Rosters with a designated team captain, record the team captain's number in the **Captain** box.
EXAMPLE: 8 is the roster Team Captain

CAPTAIN

8	○										
----------	---	--	--	--	--	--	--	--	--	--	--

- a. This player is always the captain when on the court.

S3.6 LINE-UP SHEETS

- S3.6.1 Obtain a **LINE-UP** sheet from each team (previously distributed to each team).
- S3.6.2 Opponents may not see the other team's **LINE-UP** sheet after it has been obtained.
- S3.6.3 Verify that a coach or team captain has signed each **LINE-UP** sheet.
- S3.6.4 Verify that Libero designations have been indicated.
- S3.6.5 Verify that a game captain is indicated using a **c** next to the player number.
 - a. If the roster team captain starts the set, he/she must be the game captain.
- S3.6.6 **[Optional]** An alternate captain may be designated on the line-up sheet using an **a** next to the player number.

USAV
7.3.2

7.3.2

S3.7

S3.6.7 Immediately return incomplete line-up sheets to the 2nd referee.

S3.7 LIBERO DESIGNATION

Use blue/black ink.

S3.7.1 A Libero may be the team, game or alternate USAV 5 captain.

S3.7.2 At the start of the match, each team must decide whether to designate two (2) Liberos USAV 19.1.1 for the match or zero (0) or one (1) Libero per set. This decision must be indicated on the **LINE-UP** sheet for Set 1.

S3.7.3 **Zero (0) or one (1) Libero** is designated on the **LINE-UP** sheet for Set 1:

- a. The empty Libero box(es) for Set 1 must contain an **X**.
- b. All remaining sets may have a maximum of one (1) Libero designated.
- c. The Libero may be a different player for each set.
- d. Record an **X** in the second Libero Box (R) on the remaining sets **LINE-UP** sheets.
- e. Record an **X** in the second Libero Box (R) in the **TEAM INFO** section for this team on all non-deciding set score sheets.

S3.7.4 **Two (2) Liberos** are designated on the **LINE-UP** sheet for Set 1:

- a. The Liberos must be the same for all sets
 - 1) Unless a Libero re-designation has occurred.
- b. Record the two Libero numbers in Libero Boxes on the remaining sets **LINE-UP** sheets.
- c. Record the two Libero numbers in the Libero boxes in the **TEAM INFO** section for this team on all non-deciding set score sheets.

S3.8 VERIFYING LINE-UP PLAYER NUMBERS

S3.8.1 No changes to player numbers may be made after the **LINE-UP** sheet has been submitted.

S3.8.2 Substitutions may be made prior to the start of any set. 7.3.5.3

S3.8.3 If rosters are used, verify the numbers on the **LINE-UP** sheet are consistent with the numbers on the roster.

S3.9 RECORDING THE GAME CAPTAIN(S)

Use blue/black ink.

S3.9.1 Record the game captain's number in the CAPTAIN circle. The game captain is designated on the **LINE-UP** sheet by a **c**.

- a. If the game captain leaves:
 - 1) An alternate captain must be designated.
- b. If the game captain returns:
 - 1) He/she will resume the duties of captain.

S3.9.2 If an alternate captain has been designated on the **LINE-UP** sheet using an **a**, record the alternate captain in the first available slot in the **CAPTAIN** section.

COBRAS Team A; Receiving; No Rosters; Libero 8 captain; 10 alternate captain;

SET 1			LIBERO
LINE-UP SHEET			Nº
TEAM COBRAS			8dX
IV	III	II	
47	10a	11	
V	VI	I	
23	2	15	
COLLEGE ENGINEERING Cobra Leader			

CAPTAIN X 8 10

Libero 8 is game captain when on the court.

10 is game captain when 8 is off the court.

S3.10 RECORDING THE LINE-UPS

Use blue/black ink.

S3.10.1 Record the starting players' uniform numbers in position order in the **SERVICE ORDER** section.

- a. Record the numbers in the middle of the top line of each box.
- b. Match the Roman numeral box on the **LINE-UP** sheet to the corresponding Roman numeral on the score sheet. Do this for both teams regardless of which team is serving first.

CAPTAIN X 8 10

Start	:	Team	COBRAS	8	Libero	X	A	B	A	S
Order	I	II	III	IV	V	VI				
	15	11	10	47	23	2				

S3.11 CHECKING PLAYERS ON THE COURT

Verify the players on the court, using the **SERVICE ORDER** section of the score sheet, as the 2nd referee checks the player's starting position on the court using the **LINE-UP** sheet.

- S3.11.1 Confirm the correct player numbers are on the court.
- S3.11.2 Confirm the player numbers are in the correct starting positions according to the service order.
- S3.11.3 Notify the 2nd referee of any discrepancies in either player numbers or starting positions.

S3.12 LEGAL SUBSTITUTES SECTION

Use blue/black ink.

S3.12.1 *National Scorers: Must record information about available substitutes in the **Legal Substitutes** section.*

S3.12.2 The Liberos are not **Legal Substitutes**.

S3.12.3 [**Optional**] If rosters are provided, record the non-starting players on the roster in the **Legal Substitutes** section.

S3.12.4 [**Optional**] If there are no available substitutes, record "NO SUBS" in the **Legal Substitutes** section.

S3.13 START TIME

Use blue/black ink.

Record the start time (using international format) in the **START TIME** box when the 1st referee whistles for the first serve. (Samples are provided in upper right section of the score sheet.)

			CAPTAIN X 8 10		
Start 09:00		Team COBRAS			
Order	I	II	III		
	15	11	10		

DURING THE SET**S4 RECORDING INFORMATION****S4.1 INFORMATION DURING THE SET**

S4.1.1 Record using either pencil or blue/black ink.

S5 CONTROLLING SERVICE

S5.1 VERIFYING CORRECT SERVER

Verify the correct server has the ball and is preparing to serve each time a player enters the service zone.

S6 RECORDING SERVICE AND RESULT

S6.1 SERVICE ROUNDS BOX

S6.1.1 Use one box for the entire term of service for each position, whether the player serves once or multiple times.

S6.1.2 The first time the correct server serves in a particular service round, record a small checkmark (✓) through the number in the corner of the appropriate **SERVICE ROUNDS** box beneath the serving player's number.

- a. The checkmark should extend from lower left to upper right of the number.



S6.1.3 When the serving team wins the rally:

- a. Record by slashing the appropriate point in the **POINTS COLUMN** for the serving team.

Points	
/	13 25
Z	14 26
3	15 27

S6.1.4 When the receiving team wins the rally:

- a. Record the exit score in the checked **SERVICE ROUNDS** box.
- 1) The exit score is the serving team's total cumulative points.
- b. Immediately record the rally point for the receiving team by slashing the appropriate point in that team's **POINTS COLUMN**.
- 1) The slashed rally point is 1 point more than that team's previous exit score, unless points have been removed due to a fault.



S6.2 LIBERO SERVING

A Libero is permitted to serve in only one rotational position during each set.

S6.2.1 Record this position by drawing a triangle

USAV
19.3.1.3

around the **Service Order** Roman numeral the first time a Libero serves in the set.

Start	:	Team	BLUE				8	Libero	X	A	A	S	X
		I	II	III	IV	V	VI	Points					
		2	16	5	10	7	4	✓	13	25			
								2	14	26			
								△	3	15	27		
								△	4	16	28		
								5	17	29			

S6.2.2 When the serving team wins the rally on a Libero's serve:
 a. Draw a triangle around the appropriate point in the **POINTS COLUMN**.

S6.2.3 When the receiving team wins the rally,
 a. Record the exit score in the checked **SERVICE ROUNDS** box.
 b. Immediately record the rally point for the receiving team by slashing the appropriate point in that team's **POINTS COLUMN**.

S6.3 RALLY BEING REPLAYED

When play is stopped and the rally is replayed due to external interference of the rally:

- S6.3.1 Record nothing on the score sheet.
- S6.3.2 Verify the visible scoreboard reflects the correct score and no points were inadvertently added or removed.

S7 RECORDING SERVICE FAULTS

S7.1 RECORDING THE SERVICE ROUND

If a wrong server, time violation, or serving team penalty occurs:

S7.1.1 On the first service of that round, do not record a checkmark (✓) through the **SERVICE ROUNDS** number.

2

S7.1.2 After the first service of that round, do not remove the checkmark (✓).

✓

S7.2 ROTATIONAL FAULT (**WRONG SERVER**)

When an incorrect player is in the service area preparing to serve:

- S7.2.1 Wait until the incorrect player contacts the ball for service.
 - a. Immediately notify the 2nd referee after

7.7

- the incorrect player contacts the ball.
- S7.2.2 Record the exit score in the **SERVICE ROUNDS** box of the player **who should have served**.
- a. No checkmark (✓) is recorded or removed.
- S7.2.3 No **REMARK** or **SANCTION** is recorded.
- S7.2.4 Any points earned during the rotational fault must be removed from the score sheet.
- a. Record an appropriate statement in the **REMARKS** section.

REMARKS
ROTATIONAL FAULT, CANCELLED
PTS 10-11, B, SET 2, 11-7

S7.3 SERVICE FAULT (*TIME VIOLATION*)

When a server fails to contact the ball in the allotted time period or for any other reason does not actually contact the ball for service after the 1st referee beckons for service:

- S7.3.1 Record the exit score in the **SERVICE ROUNDS** box of that server.
- a. No checkmark (✓) is recorded or removed.
- S7.3.2 No **REMARK** or **SANCTION** is recorded.

12.4.4
USAV
12.4.4

S8 RECORDING GAME CAPTAIN CHANGES

During play, there must always be a game captain on the court. 5.1.2

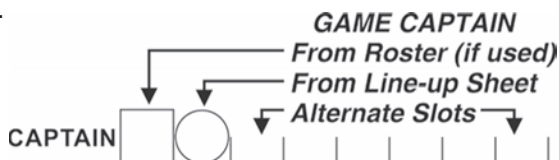

S8.1 TEAM CAPTAIN FROM ROSTER (IF ROSTERS ARE USED)

- S8.1.1 When the team captain indicated on the roster (in the **Captain** box) is on the court, he/she is the game captain. S3.5

S8.2 TEAM CAPTAIN FROM LINE-UP SHEET

- S8.2.1 When the team captain indicated on the line-up sheet (in the **Captain** circle) is on the court, he/she is the game captain. S3.9

S8.3 TEAM CAPTAIN LEAVES THE COURT

USAV

S8.3.1 An alternate player on the court must be assigned the role of game captain.

5.1.2

S8.3.2 When no alternate game captain is recorded in the alternate slots:

CAPTAIN X 8 | | | | | | | |

- Inform the 2nd referee that an alternate game captain needs to be assigned.
- Record the alternate game captain's number in the first available alternate slot.

S8.3.3 When an alternate game captain is recorded in the alternate slots:

CAPTAIN X 8 10 | | | | | | | |

- Report the alternate game captain's number to the 2nd referee (**10** in the diagram above)

S8.4 ALTERNATE GAME CAPTAIN LEAVES THE COURT

S8.4.1 Inform the 2nd referee that a new alternate game captain needs to be assigned.

S8.4.2 Slash the exiting number in the alternate slots.

S8.4.3 Record the new alternate game captain's number in the next available alternate slot.

Example: 10 leaves the court and 9 is the alternate captain.

CAPTAIN X 8 ~~10~~ 9 | | | | | | | |

Note: When 10 re-enters the court, 9 remains the alternate game captain.

S9 SUBSTITUTIONS

15.5

S9.1 GENERAL INFORMATION

S9.1.1 Each team is limited to 12 team substitutions per set.

USAV

S9.1.2 Players may enter a set an unlimited number of times within the team substitution limit, but always in the same rotational position relative to teammates.

15.6

S9.1.3 An unlimited number of players are allowed to substitute into a given rotational position.

S9.2 LEGAL SUBSTITUTIONS

- A legal substitution must meet all the following:
- S9.2.1 The request must be within the team substitution limit. USAV 15.6
- S9.2.2 When using rosters:
- The substitute must be on the roster.
 - 1) National Scorers: Available substitutes must have been recorded in the **Legal Substitutes** section.*
- S9.2.3 The substitute must enter in the correct rotational position.
- S9.2.4 **The substitute cannot have been:**
- Replaced by an exceptional substitution during the match;
 - Declared unable to play during the match;
 - Expelled during the set;
 - Disqualified during the match.

S9.3 ADMINISTERING SUBSTITUTIONS

- When the 2nd referee authorizes a substitution.
- S9.3.1 Confirm the legality of the substitution.
- Immediately notify the 2nd referee if the substitution is not legal. USAV 15.9
 - Remove any incorrectly recorded substitution information (if any). USAV 15.6
- S9.3.2 Record the substitution.
- S9.3.3 Notify the 2nd referee when a team has used its 9th, 10th, 11th, and 12th substitutions.
- S9.3.4 Display the **READY** signal to the 2nd referee. S1.8

S9.4 MULTIPLE SUBSTITUTIONS (SAME TEAM)

- The 2nd referee will authorize a pair to exchange followed by another pair until all substitutions have been completed.
- S9.4.1 Administer each substitution separately using the procedures above.
- Confirm legality.
 - Record substitution.
 - Notify 2nd referee of 9th, 10th, 11th, 12th team substitutions.
 - Display the ready signal to confirm each substitution has been recorded. S1.8

S9.5 SIMULTANEOUS SUBSTITUTION BY BOTH TEAMS

When both teams request substitutions during the same dead ball.

- S9.5.1 Administer each substitution in the same order as authorized by the 2nd referee.

S9.3

S9.6 RECORDING SUBSTITUTIONS

- S9.6.1 Record the substitution in the first available row in the **Score at Substitution** section beneath the player number leaving the set.

IV	
2	
9	3:2
	:

- Record the entering player number in the left box.
- Record the score at time of substitution in the right box.

S1.5

- S9.6.2 Record the total number of team substitutions used by slashing the next

3	6	3	6
Substitutions / 2 3			

un-slashed number in the **Substitutions** row beneath the **SERVICE ROUNDS** section.

- S9.6.3 When rosters are used and this is the first time the player has entered the game:

- Slash the player number in the **Legal Substitutes** section.
- National Scorers: Must slash the player number in the **Legal Substitutes** section.*

S9.7 RECORDING MORE THAN EIGHT (8) SUBSTITUTIONS IN ONE ROTATIONAL POSITION

- S9.7.1 Record the substitution in the available **SCORE at SUBSTITUTION** boxes in an adjoining column.

- S9.7.2 Draw a dark line around the adjoining **SCORE at SUBSTITUTION** column area to indicate this information belongs with the original substitution position (see diagram at the top of the next page).

I	II	III	IV	V	VI
2	16	5	10	7	4
:	:	3 1:2	:	:	:
:	:	5 2:4	:	:	:
:	:	3 8:7	:	:	:
:	:	5 9:8	:	:	:
:	:	3 12:12	3 21:17	:	:
:	:	5 13:12	5 22:18	:	:
:	:	3 18:14	3 24:24	:	:
:	:	5 19:15	5 25:24	:	:

15.7

S10 EXCEPTIONAL SUBSTITUTIONS

15.7

S10.1 WHEN PERMITTED

S10.1.1 An injured or ill player (except a Libero) who cannot continue playing should be substituted legally or, if in the back row, legally replaced by the Libero

S10.1.2 If this is not possible, the team is entitled to make an exceptional substitution.

S10.2 PRIORITY FOR EXCEPTIONAL SUBSTITUTION

USA V

S10.2.1 By the starter or a substitute who has played in the position of the injured player, or by any substitute who has not already participated in the set;

S10.2.2 By any substitute on the bench, regardless of position previously played;

S10.2.3 By the Libero.

15.7a

S10.3 RECORDING EXCEPTIONAL SUBSTITUTIONS

S10.3.1 Circle the injured player's number in the

SERVICE ORDER or **SCORE** at **SUBSTITUTION** section to

indicate that the player is prohibited from returning to the match.

III	IV
2	6
:	14 :

S10.3.2 Record the incoming player's number in the next available substitution box.

S10.3.3 **Do not** record the score in the **SCORE** at

15.7

SUBSTITUTION section.

S10.3.4 **Do not** slash any substitution number in the **Substitutions** row beneath the **SERVICE ROUNDS** section. An exceptional substitution is not counted as one of the team's allowable team subs.

S10.3.5 RECORD REMARKS

- a. Record a comment in the **REMARKS** section, noting the action (EX SUB), the uniform numbers of the incoming player and injured player, the team name or letter designation, the set number, and the score at the time of the exceptional substitution.

S1.5

REMARKS
EX SUB, #12 FOR #16, A, SET 1, 9-12

- b. If more sets will be played in the match:
- 1) Record this remark onto all subsequent score sheets.
 - 2) This player will be recorded in the **Legal Substitutes** section of subsequent score sheets inside a circle. This indicates that this player cannot be used as a **legal substitute**.

S10.4 EXCEPTIONAL SUBSTITUTIONS INVOLVING THE LIBERO

USAV
15.7a

As the last option, a Libero may be used as the exceptional substitute.

S10.4.1 If the team has two Liberos, either Libero may be selected as the exceptional substitute and the team will be limited to one Libero for the remainder of the match.

S10.4.2 If the team is using one Libero, the team will play the remainder of the match with no Libero.

S10.4.3 Record the selected Libero's number in the next available substitution box.

S10.4.4 **Do not** record the score in the **SCORE at SUBSTITUTION** section.

S10.4.5 RECORD THE EXCEPTIONAL SUBSTITUTE

- a. Slash the selected Libero's number in the Libero# box next to the team name.

- b. The Libero's number is also slashed on the Libero Control Sheet.

Start	09:00		Team	EAGLES			Libero#	11 3		A	A	S
	I	II	III	IV	V	VI						
	2	16	5	12	7	4						
	:	11	:	:	:	:	:	:	:	:	:	:

- c. If more sets will be played in the match:
 1) Record this remark onto all subsequent score sheets.
- d. **When two (2) Liberos are designated for the match** and more sets will be played:
 1) Record this slash onto all subsequent set score sheets and the Libero Control Sheet.

Set 2

A	A	Libero#	Team	End
X	R	11	EAGLES	:

S10.4.6 RECORD REMARKS

- a. Record a comment in the **REMARKS** section as follows:

REMARKS
EX SUB LIBERO #11 FOR #16, A, SET 1,9-12

S11 TIME-OUTS

S11.1 RECORDING TIME OUTS

S11.1.1 Record the score at the time-out in the **TIME-OUTS** box located under the team's **POINTS COLUMN** section.

Time Outs	Time Outs
7:10	12:13
22:20	:

S1.5

S11.1.2 Record the first time-out in the top box.

S11.1.3 Record the second time-out in the lower box.

S11.2 COMMUNICATING WITH SECOND REFEREE

S11.2.1 Immediately after recording the time-out:

- a. Visually signal the number of time-outs taken by each team to the 2nd referee.

S11.2.2 At the conclusion of the time-out:

- a. Display the ready signal to the 2nd referee. S1.8

S12 IMPROPER REQUEST

15.11

The **IMPROPER REQUEST** section is used to denote that a team has made an improper request.

S12.1 RECORDING AN IMPROPER REQUEST

- S12.1.1 Record an **X** over the appropriate A or B for the team that made the improper request



- S12.1.2 If more sets will be played in this match;
a. Record this Improper Request onto all subsequent score sheets.
- S12.1.3 A team may be charged with an improper request after being sanctioned with a delay.

S13 SANCTIONS BOX

15.11

S13.1 GENERAL INFORMATION

- S13.1.1 The **SANCTIONS** section is used to record sanctions applied by the 1st referee.
- S13.1.2 Information recorded in the **SANCTIONS** section needs no further notation in the **REMARKS** section.
- S13.1.3 Each recorded sanction should include:
a. the specific sanction:
1) delay or misconduct warning,
2) delay or misconduct penalty,
3) expulsion or disqualification;
b. the player number or bench personnel code (if applicable);
c. the team at fault (use **A** or **B** team designation);
d. the set number;
e. the score at the time of the sanction.
- S13.1.4 If more sets will be played in the match:
a. Record **all sanctions** onto all subsequent score sheets.
- S13.1.5 When a penalty is recorded in the **Penalty** column, there must be a corresponding penalty point recorded in the opponent's **Points** column.

S13.2 DELAY WARNING

(Yellow card shown on wrist)

S13.2.1 Record a **D** in the **W Warn** column, record the team at fault, the set number, and the score.

	W Warn	P Penalty	E Expel	D DisQ	(A) (B)	SET	SCORE
S					(A) (B)		
A	D				B	3	8:5

- a. There is only one yellow card delay warning per team/per match.

S13.3 MISCONDUCT WARNING (Yellow card)

S13.3.1 Record the player number or bench personnel code (refer to the legend next to the **SANCTIONS** box) in the **W Warn** column, record the team at fault, the set number, and the score.

	W Warn	P Penalty	E Expel	D DisQ	(A) (B)	SET	SCORE
S					(A) (B)		
A	C				A	1	7:6

- a. There is only one yellow card misconduct warning per team/per match.

S13.4 DELAY PENALTY (Red card shown on wrist)

S13.4.1 Record a **D** in the **P Penalty** column, the team at fault, the set number, and the score at the time of the penalty.

	W Warn	P Penalty	E Expel	D DisQ	(A) (B)	SET	SCORE
S					(A) (B)		
A		D			A	2	3:4

Team B	
Points	
/	13:25
/	14:26
/	15:27
/	16:28
⊗	17:29

S13.4.2 If penalty is against the serving team, record the serving team's exit score.

S13.4.3 Record the awarded penalty point. Slash and circle the opposing team's next point in the **POINTS COLUMN**.

16.2.2

21.1

16.2.3

S1.5

S13.1.5
S1.6

S13.5 MISCONDUCT PENALTY (Red card)

S13.5.1 Record the player number or bench personnel code (refer to the legend next to the SANCTIONS box), in the **P Penalty** column, the team at fault, the set number, and the score at the time of the penalty.

	W Warn	P Penalty	E Expel	D DisQ	(A) (B)	SET	SCORE
S							
A		5			B	3	6:2

Team A

	Points
✓	13:25
✓	14:26
⊘	15:27
4	16:28
5	17:29

S13.5.2 If penalty is against the serving team, record the serving team's exit score.

S13.5.3 Record the awarded penalty point. Slash and circle the opposing team's next point in the **POINTS COLUMN**.

S13.6 MISCONDUCT EXPULSION (Red and Yellow card shown together)

S13.6.1 A team member sanctioned by expulsion;

- Shall not play for the rest of the set;
- Must be substituted legally and immediately if on the court.
(Exceptional Substitution is not permitted)
Otherwise, the team is incomplete.
- May not remain on the bench
(Seated in penalty area if available)

S13.6.2 RECORD THE EXPULSION

- Record the player number or bench personnel code (refer to the legend next to the **SANCTIONS** box), in the **E Expel** column, the team at fault, the set number, and the score at the time of the expulsion.

	W Warn	P Penalty	E Expel	D DisQ	(A) (B)	SET	SCORE
S							
A			8		B	2	8:5

- No loss of service or penalty point awarded.***

S13.6.3 RECORD THE REQUIRED LEGAL SUBSTITUTION

- Circle the expelled player's number in the **SERVICE ORDER** or **SCORE AT SUBSTITUTION** section indicating the player shall not play for the rest of this set.

- b. Complete recording the substitution using the procedure as outlined in **S9.6**.

I	II	III	IV	V	VI
2	8	5	12	7	4
:	6 8:5	:	:	:	:

Substitutions 2 3 4 5 6 7 8 9 10 11 12

21.3.3

S13.7 MISCONDUCT DISQUALIFICATION (Red and Yellow card shown apart)

S13.7.1 A team member sanctioned by disqualification: 21.3.3.1

- a. Must be substituted legally and immediately if on the court.
(Exceptional Substitution is not permitted.)
Otherwise, the team is incomplete.
- b. Must leave the Competition-Control Area for the rest of the match. **(Must leave the Gym.)**

S13.7.2 RECORD THE DISQUALIFICATION

- a. Record the player number or bench personnel code (refer to the legend next to the **SANCTIONS** box), in the **D DisQ** column, the team at fault, the set number, and the score at the time of the disqualification.

S13.7.3 RECORD THE DISQUALIFICATION

- a. Record the player number or bench personnel code (refer to the legend next to the **SANCTIONS** box), in the **D DisQ** column, the team at fault, the set number, and the score at the time of the disqualification.

S1.5

	W Warn	P Penalty	E Expel	D DisQ	(A) (B)	SET	SCORE
S				9	B	2	8:7
A							

- b. **No loss of service or penalty point awarded.** 21.3.3.1

S13.7.4 RECORD THE REQUIRED LEGAL SUBSTITUTION

- a. Circle the disqualified player's number in the **SERVICE ORDER** or **SCORE AT SUBSTITUTION** section indicating the player shall not play for the rest of the match.
- b. Complete recording the substitution using the procedure as outlined in **S9.6**.
- c. This player will be recorded in the

Legal Substitutes section of subsequent score sheets inside a circle.

This indicates that this player cannot be used as a legal substitute.

I	II	III	IV	V	VI
2	8	5	12	7	4
:	:	:	⑨ 3:4	:	:
:	:	:	6 8:7	:	:
Substitutions Z 3 4 5 6 7 8 9 10 11 12					

S14 REMARKS SECTION

S14.1 USE of the REMARKS Section.

S14.1.1 **Do Not** record frivolous remarks.

S14.1.2 Record any noteworthy situation that occurs and is pertinent to the progress of the set.

S14.1.3 Record information that cannot be recorded in the **SANCTIONS** box:

- a. Reason for Referee actions such as:
 - 1) Defaulted/Forfeited set;
 - 2) Points cancelled by referees;
 - 3) Unusually long delays not covered by delay sanctions.
- b. Late Match Start
- c. Teams in DEFAULT;
- d. FORFEITs;
- e. Incomplete teams;
- f. Exceptional Substitutions (EX SUB);
- g. Penalties that cannot be recorded in the **SANCTIONS** box:
 - 1) Late work teams, violation of event rules;
- h. Other.

S14.1.4 Record additional information as needed:

- a. Player number or bench personnel code;
- b. Team (A or B);
- c. Set number;
- d. Score at time of situation.

S14.2 PREFERRED RECORDING TECHNIQUES

S14.2.1 (**Preferred Technique**) Record information in the **REMARKS** section in the same order as the **SANCTIONS** box.

S14.2.2 The order of recording information in the **REMARKS** section is not critical as long as all necessary information is recorded.

S14.3 EXAMPLE OF LATE START AND LATE WORK TEAM PENALTY

REMARKS
LATE START DUE TO PREVIOUS MATCH
LATE WORK TEAM PREVIOUS MATCH, B,
3 PT PENALTY

Team A		
Points		
①	13	25
②	14	26
③	15	27
4	16	28

S14.3.1 Record the awarded penalty points. Slash and circle first three points in Team A's POINTS COLUMN.

S1.6

19.4.1

S15 SCORING ACTIONS INVOLVING THE LIBERO

S15.1 LIBERO UNABLE TO PLAY DUE TO ILLNESS, INJURY OR DECLARATION

S15.1.1 REMARKS

- Record a comment in the **REMARKS** section when any Libero becomes unable to play.

REMARKS
LIBERO #11 UNABLE TO PLAY, A, ...
SET 1,8-6

- If more sets will be played in the match:
 - Record this remark onto all subsequent score sheets.

S15.1.2 RECORD THE LIBERO (**UNABLE TO PLAY**) 19.4.1

- Circle the number of the Libero unable to play (next to the team name). This player will be unable to play for the remainder of the match.

Start	09:00	Team	EAGLES	Libero#	①	X	A	A	S
-------	-------	------	--------	---------	---	---	---	---	---

- The Libero number is also circled on the Libero Control Sheet.
- When two (2) Liberos are designated for the match and more sets will be played:**
 - Record this circle onto all subsequent set score sheets and the Libero Control Sheet.

Set 2

X	A	A	S	Libero#	①	3	Team	EAGLES	End	:
---	---	---	---	---------	---	---	------	--------	-----	---

S15.2 AN EXPELLED LIBERO

- S15.2.1 A Libero sanctioned by expulsion; 21.3.2
- Shall not play for the rest of the set;
 - Must be replaced immediately, if on the court.
 - May not remain on the bench
(Seated in penalty area if available)

S15.2.2 RECORD THE EXPULSION

- Record the Libero number in the **E Expel** column, the team at fault, the set number, and the score at the time of the expulsion.

	W Warn	P Penalty	E Expel	D DisQ	(A) (B)	SET	SCORE
S							
A			11		A	1	8 : 6

- No loss of service or penalty point awarded.** 21.3.2.1

S15.2.3 RECORD THE EXPELLED LIBERO

- Circle the number of the expelled Libero (next to the team name).

Start: 09:00	Team: EAGLES	Libero of (11) X	(A) (B) (S) (x)
--------------	--------------	------------------	-----------------

- The Libero number is also circled on the Libero Control Sheet.

S15.3A DISQUALIFIED LIBERO

- S15.3.1 A Libero sanctioned by disqualification; 21.3.3
- Must be replaced immediately, if on the court.
 - Must leave the Competition-Control Area for the rest of the match. **(Must leave the Gym.)**

S15.3.2 RECORD THE DISQUALIFICATION

- Record the Libero number in the **D DisQ** column, the team at fault, the set number, and the score at the time of the disqualification.

	W Warn	P Penalty	E Expel	D DisQ	(A) (B)	SET	SCORE
S							
A				3	A	1	4 : 9

- No loss of service or penalty point awarded.** 21.3.3.1

S15.3.3 RECORDING THE DISQUALIFIED LIBERO

- Circle the number of the disqualified

Libero (next to the team name)

Start	09:00	Team	EAGLES	Libero#	(3)	X	A	B	S
-------	-------	------	--------	---------	-----	---	---	---	---

- b. The Libero number is also circled on the Libero Control Sheet.
- c. **When two (2) Liberos are designated for the match** and more sets will be played:
 - 1) Record this circle onto all subsequent set score sheets and the Libero Control Sheet.

Set 2

X	A	B	(11)	Libero#	3	Team	EAGLES	End	:
---	---	---	------	---------	---	------	--------	-----	---

S15.4 LIBERO REDESIGNATION

- S15.4.1 Libero redesignation is permitted only when a team has only one Libero and that Libero becomes unable to play. 19.4
19.4.2
- S15.4.2 If the team redesignates a Libero, record the redesignation in the **REMARKS** section.

REMARKS	
REDESIGNATED LIBERO #8, A,	
SET 1, 10-8	

S15.4.3 RECORD THE REDESIGNATED LIBERO

- a. Record the number of the redesignated Libero above the Libero box (next to the team name).

Start	09:00	Team	EAGLES	Libero#	(11)	X	A	B	S	
I	II	III	IV	V	VI					
2	8	5	12	7	4					
:	12	8:7	:	:	:	:				

- b. This number is also recorded on the Libero Control Sheet for the current set.
- c. **When two (2) Liberos are designated for the match** and more sets will be played:
 - 1) Record this number onto all subsequent set score sheets and the Libero Control Sheet.

Set 1

Start	09:00	Team	EAGLES	Libero#	(11)	(3)	A	B	S
-------	-------	------	--------	---------	------	-----	---	---	---

Set 2 8

X	A	B	(11)	Libero#	(3)	Team	EAGLES	End	:
---	---	---	------	---------	-----	------	--------	-----	---

S16 SET POINT SIGNAL

S16.1 NOTIFY THE 2ND REFEREE WHEN EITHER TEAM'S NEXT POINT WOULD END THE SET.

- S16.1.1 Place the index finger on the front of the shoulder on the side of the team with the set point.
- a. Repeat the signal only if a different set point situation occurs.

S17 POST SET PROCEDURES

S17.1 FINAL POINT SCORED

- S17.1.1 Slash the final point in the **POINTS** column.
- S17.1.2 Cross forearms in front of the chest (palms facing toward body) to indicate the end of the set/match.
- S17.1.3 Record the point total as the final exit score.
- a. When final point is scored by the serving team:
 - 1) Record the final exit score in the current **SERVICE ROUNDS** box.
 - b. When final point is scored by the receiving team on the opponent's loss of rally:
 - 1) Record the final exit score in the next available **SERVICE ROUNDS** box. 
 - 2) **Do not record** a checkmark (✓) through the **SERVICE ROUNDS** box number.

S17.2 FROM THIS POINT FORWARD RECORD ALL INFORMATION USING BLUE/BLACK INK

S17.3 END TIME AND FINAL EXIT SCORES

Use blue/black ink.

- S17.3.1 Record the set ending time in the **END TIME** box.  S1.4
- a. End time is when the referees ended the final rally.

- S17.3.2 Circle the final exit score in the **SERVICE ROUNDS** box for each team

X	4	3	5	10	18	22
24	5	25	5	2	5	2
3	6	6	3	6	3	6

S17.4 POINTS COLUMN

Use blue/black ink.

S17.4.1 Do not circle the final point in the **POINTS** column, unless it was the result of a penalty point.

S17.4.2 Cancel all unused points using the **T-Bar Method**.

S17.4.3 **T-Bar Method**

a. At the end of each set, using a straight edge:

- 1) Draw a horizontal line across the column underneath the last point recorded.
- 2) Draw a vertical line through the numbers from the horizontal line to the bottom of the column.
- 3) For each unused column containing a number, draw a vertical line through the numbers from top to bottom of the column.

Points	Points
1 13 25	1 13 25
2 14 26	2 14 26
3 15 27	3 15 27
4 16 28	4 16 28
5 17 29	5 17 29
6 18 30	6 18 30
7 19 31	7 19 31
8 20 32	8 20 32
9 21 33	9 21 33
10 22 34	10 22 34
11 23 35	11 23 35
12 24 36	12 24 36

S17.5 SET RESULTS

Use blue/black ink.

S17.5.1 Record the winning team name and score in the upper section (**Winning**) of the appropriate **SET RESULTS** box.

S17.5.2 Record the losing team name and score in the lower section (**Losing**) of the appropriate **SET RESULTS** box.

TEAM	SET RESULTS	Score
Winning	EAGLES	25
Losing	COBRAS	10

S17.6 SCORE SHEET REVIEW

S17.6.1 Review for completeness and accuracy

- a. Start and End Times
- b. Confirm substitutions areas all agree
 - 1) Count substitutions in **SCORE at SUBSTITUTION** section.
 - 2) Compare to total substitutions in **Substitutions** row.

S17.6.2 Check accuracy of scores by matching:

- a. Final Exit Score;

- b. Last Point recorded in **POINTS** column;
 - c. Scores recorded in **SET RESULTS**.
- S17.6.3 Check accuracy of **SET RESULTS**
- a. Winning and Losing Teams are correct;
 - b. Scores are accurately recorded and match other scores.

S17.7 SIGNATURE

Use blue/black ink.

When using the 1-up score sheet.

S17.7.1 Sign the score sheet after the review.

When using the 2-up score sheet.

S17.7.2 Sign the score sheet after the 2nd set has been completed and reviewed.

SIGNATURES	
Scorer	<i>Scorer's Signature</i>
1st Referee	

S17.8 PREPARING ADDITIONAL SCORE SHEETS

S17.8.1 Record all sanctions and pertinent remarks that affect the administration of remaining sets onto all subsequent score sheets.

S17.8.2 Verify all players either disqualified or replaced through exceptional substitution are not listed as **Legal Substitutes**.

S18 POST MATCH PROCEDURES

Upon completion of the Match

S18.1 RECORD MATCH RESULTS

Use blue/black ink.

S18.1.1 Record the winning team name in the **MATCH WINNER** box on all score sheets used in the match.

S18.1.2 Record the number of sets won and lost.

TEAM	MATCH WINNER	Sets	W	L
EAGLES			2	1

S18.1.3 If a tie occurs (some competitions play two sets only) record **SPLIT/TIED** as the winning team.

TEAM	MATCH WINNER	Sets	W	L
SPLIT/TIED			1	1

S18.2 1st REFEREE SIGNATURE

Use blue/black ink.

S18.2.1 Assist the 1st referee (as needed) as he/she reviews and signs all used score sheets.

SIGNATURES	
Scorer	<i>Scorer's Signature</i>
1st Referee	<i>First Referee Signature</i>

S18.3 SCORE SHEETS

S18.3.1 Process completed score sheets as instructed by tournament management.

S18.4 SCORER TABLE

S18.4.1 Before leaving:

- a. Discard all work papers, Line-up Sheets, Libero Control Sheet.
- b. Remove all personal items;
- c. Discard all trash.

S19 DECIDING SET SCORE SHEET

S19.1 DECIDING SET SCORE SHEET

A deciding set score sheet is used for multiple match situations:

- S19.1.1 When a best-of-three match is tied 1-1 or a best-of-five match is tied 2-2, a deciding set is played. 6.3
USAV
6.3
- a. The set is played to fifteen (15) points with a minimum lead of two (2) points. 6.3.2
- b. Teams will change courts at eight (8) points. 18.2.2
USAV
- S19.1.2 When a playoff set to twenty-five (25) points is played. 6.3b
- a. The set is played to twenty-five (25) points with a minimum lead of two (2) points.
- b. Teams will change courts at thirteen (13) points.
- S19.1.3 When a playoff set to fifteen (15) points is played. USAV
6.3b
- a. The set is played to fifteen (15) points with a minimum lead of two (2) points.
- b. Teams will change courts at eight (8) points.
- S19.1.4 When the third set of an 'automatic 3 set' match is played like a deciding set.
- a. A coin toss is conducted.
- b. The set is played to twenty-five (25) points with a minimum lead of two (2) points.
- c. Teams will change courts at thirteen (13) points.

S19.2 CHARACTERISTICS OF A DECIDING SET SCORE SHEET

S19.2.1 A deciding set score sheet contains:

- a. All the information of a non-deciding set score sheet.
- 1) Due to the change of courts, scoring information is recorded differently than in a non-deciding set.
- b. A **LEFT** section which is:
- 1) Used to record scoring information about the team starting on the **left** court.

- 2) **Not used after the court change.**
- c. A **MIDDLE** section which is
 - 1) Used to record scoring information about the team starting on the **right** court and finishing on the **Left** court;
 - 2) Used during the entire set.
- d. A **RIGHT** section which is:
 - 1) **Used before the court change**, to record certain information about the team starting on the **left** court.
 - 2) **Used after the court change**, to record all scoring information about the team now on the **right** court.

S19.3 PREPARING A DECIDING SET SCORE SHEET

Use blue/black ink.

- S19.3.1 Record **3, 5** or **1** (for a single playoff set) in the **Set** box.
- S19.3.2 Record all heading information and all officials' names.
- S19.3.3 Record all sanction information from the previous score sheets (if any).
- S19.3.4 Record any pertinent information in the **REMARKS** section from the previous score sheets (if any).

S19.4 AFTER THE COIN TOSS

Use blue/black ink.

- S19.4.1 For the team starting on the **left** court:
 - a. Record all information on both the **LEFT** and **RIGHT** sections.
- S19.4.2 For the team starting on the **right** court:
 - a. Record all information on the **MIDDLE** section.
- S19.4.3 Record the following information:
 - a. Team **A/B** designation from **Set 1** in the **A/B** circle.
 - 1) For a one (1) set playoff the team starting on the **left** court will be designated Team **A**.
 - b. Team **Name** in the **TEAM INFO** section.
- S19.4.4 Record and Serve Receive.
 - a. For the team serving first:
 - 1) Record an **X** through the **Ⓢ**;

S20.3 WHEN THE COURT CHANGE POINT IS SCORED

- S20.3.1 The court change point is either eight (**8**) for a fifteen (**15**) point set or thirteen (**13**) for a twenty-five (**25**) point set.
- S20.3.2 Notify the 2nd referee that the court change point has been scored.
- a. At this time, the teams will change courts as directed by the 1st referee.
- S20.3.3 If a team scores the court change point from the opponent's serve:
- a. Record the opponent's exit score;
 - b. Record the rally point for the receiving team. S6.1.4b

S20.4 AT THE COURT CHANGE

- S20.4.1 Verify that all visual scoreboards are changed to reflect the court change.
- S20.4.2 Record the current score of the team from the **LEFT** section (prior to court change) in the **Points at Chg** circle on the **RIGHT** section.
- a. **Points at Chg** circle is located to the left of the team name.
 - 1) The first point in the **RIGHT** section **POINTS COLUMN** will be the number following the number in the **Points at Chg** circle.
- S20.4.3 The **anchor point**:
- a. Is the last exit score from the **LEFT** section;
 - 1) Is always recorded regardless of whether the team is serving or receiving;
 - 2) If the team that started on the **left** court has not served before the court change, the **anchor point** is the **X**;
- S20.4.4 Record the **anchor point** on the **RIGHT** section.
- a. Do not record the checkmark (✓).

EXAMPLE

COBRAS serve point 8, change courts and serve point 9 and then lose the next rally.

COURT													COURT													COURT												
COBRAS													EAGLES													COBRAS												
I	II	III	IV	V	VI	Points	I	II	III	IV	V	VI	Points	I	II	III	IV	V	VI	Points at Chg.	Set																	
15	8	10	47	23	2		9	3	1	14	5	7		15	8	10	47	23	2	8	3																	
7:2:3							7:2:3							7:2:3																								
Time Outs							Time Outs							Time Outs																								
1:3							1:3							5:9																								
Substitutions 2 3 4 5 6 7 8 9 10 11 12													Substitutions 1 2 3 4 5 6 7 8 9 10 11 12													Substitutions 2 3 4 5 6 7 8 9 10 11 12												

S20.5 AFTER THE COURT CHANGE

- S20.5.1 The **LEFT** section is no longer used.
- S20.5.2 Complete the set recording all information on the **MIDDLE** and **RIGHT** section.

S21 POST DECIDING SET PROCEDURES

- S21.1 **RECORD FINAL POINT SCORED BY WINNING TEAM** S17.1
- S21.2 **FROM THIS POINT FORWARD RECORD ALL INFORMATION USING BLUE/BLACK INK** S17.2
- S21.3 **RECORD THE END TIME AND FINAL EXIT SCORES** S17.3
Use blue/black ink.
- S21.4 **POINTS COLUMN** S17.4.3
Use blue/black ink.
 - S21.4.1 Using the **T-Bar** method:
 - a. Cancel all unused points on the **MIDDLE** and **RIGHT Points** columns **ONLY**.
 - b. **DO NOT CANCEL** the unused points on the **LEFT Points** column.
- S21.5 **REVIEW THE SCORE SHEET** S17.6
- S21.6 **SIGN THE SCORE SHEET** S17.7
Use blue/black ink.

S23.1.6 Record a remark in the **REMARKS** section.

S23.1.7 All penalty points removed must be restored.

- a. A remark specifying the number of penalty points restored must be made in the **REMARKS** section.

REMARKS
ILLEGAL PLAYER ON CT, PTS 11-14
REMOVED, B, SET 2, 14-8

S23.1.7 No previously recorded exit scores are changed.

S23.1.8 When the team at fault is serving:

- a. Remove points in the **POINTS COLUMN**;
- b. Opponents are awarded a point and service;
 - 1) Record this slashed *rally point*.
- c. Record the exit score that reflects the score after all points have been removed.

S6.1.4b

S23.1.9 When the team at fault is receiving:

- a. Remove points in the **POINTS COLUMN**;
- b. Do not change any previously recorded exit scores.

S23.1.10 When the team at fault wins the serve:

- a. They will start at the revised score;
- b. The exit score will reflect the new score.

S23.1.11 The team at fault may have a current exit score less than the previously recorded exit score.

EXAMPLE

TEAM B AT FAULT (SERVING)

- A wrong player entered when Team B had 10 points
- #4 is serving

Team B - Exit Scores before fault discovered

I	II	III	IV	V	VI
2	8	5	12	7	4

1 [✓]	4 [✓]	7 [✓]	10 [✓]	14 [✓]	
----------------	----------------	----------------	-----------------	-----------------	--

- Fault is discovered during #4's term of service
- Team B's score goes back to 10 (removal of points)
- Team A awarded point and service

S23.2.6

Team B - Exit Scores after removing points

I	II	III	IV	V	VI
2	8	5	12	7	4

1 [✓]	4 [✓]	7 [✓]	10 [✓]	14 [✓]	10 [✓]
----------------	----------------	----------------	-----------------	-----------------	-----------------

TEAM B AT FAULT (RECEIVING)

- A wrong player entered when Team **B** had **10** points
- Team **A** is serving

Team B - Exit Scores before fault discovered

I	II	III	IV	V	VI
2	8	5	12	7	4
1 [✓] 4	4 [✓] 4	7 [✓] 4	10 [✓] 4	14 [✓] 4	1 4

- Fault is discovered during Team **A**'s term of service
- Team **B**'s score goes back to **10** (removal of points) S23.2.6
- Team **A** loses the serve
- Team **B**'s score is **11** when Team **B 4** begins the term of service
- Team **B 4** serves into the net

Team B - Exit Scores after 4 completes term of service

I	II	III	IV	V	VI
2	8	5	12	7	4
1 [✓] 4	4 [✓] 4	7 [✓] 4	10 [✓] 4	14 [✓] 4	11 [✓] 4

S24 PROTESTS

USAV
5.1.2.1

S24.1 When a protest is accepted by the 1st referee:

S24.1.1 When a Protest Committee makes an immediate ruling before play is resumed:

- In the **REMARKS section**:
 - Record that a protest has been accepted.
 - Do not record** the protest facts.
 - Record the decision (UPHELD/DENIED).
 - Record any time delay caused by the protest as directed by the referees.
 - As a courtesy, scorer may track the time delay.

REMARKS
PROTEST, B, SET 2, 11-9, DENIED, . . .
15 MIN DELAY

S24.1.2 When a ruling is not immediate:

- In the **REMARKS section**:
 - Record that a protest has been accepted.
 - Record the Protest facts as specified in USAV 5.1.2.1.

USAV
5.1.2.1

REMARKS
PROTEST, B, SET 2, 11-9,
PROTEST FACTS PER USAV 5.1.2.1 . . .

S25 FORFEITS

S25.1 A FORFEIT OF SETS OR MATCHES CAN OCCUR FOR REASONS SUCH AS:

- S25.1.1 Team declared in default for:
 - a. Refusal to play; 6.4.1
 - b. Not appearing on playing court on time. 6.4.2
- S25.1.2 Team declared INCOMPLETE for the set or match. 6.4.3
- S25.1.3 Team does not have six players to begin a match. USAV 7.3.1

S25.2 A TEAM DECLARED IN DEFAULT FORFEITS THE MATCH WITH:

- S25.2.1 The match result of:
 - a. 0-3 for a best-of five match; 6.4.1
 - b. 0-2 for a best-of-three match-set. USAV 6.4
 - c. The score for each set will be 0-25. 6.4.1
 - 1) Any sets completed will revert to a score of 0-25.

S25.3 A TEAM DECLARED INCOMPLETE FOR THE SET OR MATCH FORFEITS THE SET OR MATCH WITH:

- S25.3.1 The incomplete team keeping all points scored and sets won; 6.4.3
- S25.3.2 The opponent given the points needed to win the set or the points and sets needed to win the set and match.

S25.4 A TEAM THAT DOES NOT HAVE SIX PLAYERS TO BEGIN THE MATCH:

- S25.4.1 Forfeits the first set at match time; USAV 7.3.1
- S25.4.2 Is given an interval of up to 10 minutes to produce sufficient players to play the next set.
- S25.4.3 If after the 10-minute interval there are still not six (6) players ready to play:
 - a. The second set is forfeit.
- S25.4.4 If the match is a best-of-three:
 - a. The match is forfeit.
- S25.4.5 If the match is a best-of-five or automatic three (3) set match:
 - a. Another interval of up to 10 minutes is given;
 - b. If after the 10-minute interval there are

still not six (6) players ready to play:

- 1) The third set is forfeit;
- 2) The match is forfeit.

S25.5 RECORDING A FORFEIT FOR AN UNPLAYED SET

Use blue/black ink.

S25.5.1 If a set number is not pre-printed in the **Set** box:

- a. Record the set number of each forfeited set:

S25.5.2 If available complete:

- a. Serving and receiving teams (**S3.3**);
- b. Team Designation (**S3.1**);
- c. Team Information (**S3.2**);
- d. Libero Designation (**S3.**);
- e. Game Captains (**S3.9**);
- f. Starting Line-ups (**S3.10**).

S25.5.3 Record the **Start** and **End** Time of the forfeited set.

S25.5.4 Write '- - - - - FORFEIT - - - - -' across the entire score sheet.

S25.5.5 In the **POINTS COLUMN**:

- a. **Do not**:
 - 1) Slash and circle any points;
 - 2) Cancel any unused points.

CAPTAIN													CAPTAIN		Set		
Start	Team	Libero						Points	Points	Libero						Team	End
09:00		I	II	III	IV	V	VI			I	II	III	IV	V	VI	09:00	
								1 13 25	1 13 25								
								2 14 26	2 14 26								
								3 15 27	3 15 27								
								4 16 28	4 16 28								
								5 17 29	5 17 29								
								6 20 32	6 20 32								
								9 21 33	9 21 33								
								10 22 34	10 22 34								
								11 23 35	11 23 35								
								12 24 36	12 24 36								

S25.6 MATCH DECLARED A FORFEIT BEFORE THE FIRST SERVE OF THE MATCH

Use blue/black ink.

S25.6.1 Record all heading information (**S2.2**).

S25.6.2 Record the officials' names (**S.2.3**).

S25.6.3 Record the first set as a forfeit (**S25.5**).

S25.6.4 In the **REMARKS** section:

- a. Record comments regarding the circumstances of the forfeit.

REMARKS
FORFEIT MATCH, EAGLES, INSUFFICIENT PLAYERS

- S25.6.5 Record the **SET RESULTS**:
- Winning TEAM**;
 - Set score of 0-25;
 - For a 2-up sheet:
 - Record both **SET 1** and **SET 2 RESULTS**.
- S25.6.6 Follow all **POST MATCH PROCEDURES (S18)**.

S25.7 FORFEIT DUE TO INSUFFICIENT PLAYERS TO START THE MATCH S25.4

Use blue/black ink.

- S25.7.1 Record all heading information (S2.2).
- S25.7.2 Record the officials' names (S.2.3).
- S25.7.3 Record the first set as a forfeit (S25.5). USAV 7.3.1
- S25.7.4 Record a remark in the **REMARKS** section.
- S25.7.5 Record the **SET RESULTS (S17.5)**.
- S25.7.6 After expiration of the 10-minute interval:
- Record remarks in the **REMARKS** section:
 - Indicating the next set is forfeited;
 - Record the **SET RESULTS (S17.5)**.
- S25.7.7 For a best-of-five or automatic three (3) set match repeat **S25.7.6** one more time.
- S25.7.8 When the match is forfeited:
- Record a remark in the **REMARKS** section.

REMARKS
FORFEIT SET 1, EAGLES, 09:00, INSUFFICIENT PLAYERS
FORFEIT SET 2 AND MATCH, EAGLES, 09:10, INSUFFICIENT PLAYERS

- Follow all **POST MATCH PROCEDURES (S18)**.

S25.8 FORFEIT AFTER SET BEGINS DUE TO INCOMPLETE TEAM S.1.6

S25.8.1 Opponent is awarded sufficient points to produce a winning score.

- Record these points in the **POINTS COLUMN** as **PENALTY POINTS (S1.6)**.
 - Slash and circle each point.

Points		
1	18	25
10	22	34
11	23	35
12	24	36

S25.8.2 Record a remark in the **REMARKS** section.

REMARKS
FORFEIT, INCOMPLETE TEAM,
B, SET 1, 18-22

S25.8.3 Follow all **POST SET PROCEDURES (S17)**.

S25.8.4 Record the remaining forfeited sets (**S25.5**).

S25.8.5 If the match is forfeited:

- a. Follow all **POST MATCH PROCEDURES (S18)**.

S25.9 FORFEIT AFTER MATCH BEGINS DUE TO TEAM BEING DECLARED IN DEFAULT

A team could be declared in default for refusing to play when directed by the referees. While this is rare, the scorer need to be prepared to record this forfeit.

S25.9.1 A team in default forfeits all sets, even those 6.4.1
already played or in progress.

- a. The set score will be 0-25 for all sets.
- b. The match score will be:
 - 1) 0-2 for a best-of-three match;
 - 2) 0-3 for a best-of-five match.

S25.9.2 For all sets played or the set in progress:

Use blue/black ink.

- a. Write '- - - - - **FORFEIT** - - - - -' across the entire score sheet.
- b. Correct the **SET RESULTS** box to reflect the opponent winning the set with a score of 0-25.

S25.9.3 Record any remaining forfeited sets (**S25.5**).

S25.9.4 Record a remark in the **REMARKS** section.

REMARKS
MATCH FORFEIT, TEAM IN DEFAULT, REFUSAL TO PLAY, B, SET 1, 18-22

S25.9.5 Follow all **POST MATCH PROCEDURES (S18)**.

NATIONAL CHAMPIONSHIP TOURNAMENT PROCEDURES

NATIONAL SCORERS WILL USE THE FOLLOWING TECHNIQUES AND PROCEDURES

N1 PROCEDURES

N1.1 INFORMATION

N1.1.1 Record all information **using blue/black ink.**

N1.2 ROSTERS

S3.4

N1.2.1 Obtain a clean, unmarked (excluding verification initials) roster from each team.

N1.2.2 No marks should be written on the roster.

a. A separate notepad/paper is used to assist the roster verification process.

1) Copy roster numbers onto the notepad and make any marks there.

N1.2.3 Roster verification

a. With the assistance of the referees:

1) Verify player uniform numbers are correct and accurate.

2) Verify gender and number of bench personnel.

N1.2.4 Photo ID Verification

a. At the request of Championship, check each team member's photo ID against the roster.

N1.2.5 Initial the roster, as verified, in the lower right hand corner.

N1.3 LINE-UP SHEETS

N1.3.1 Process using procedures **S3.6-S3.12.**

N1.4 LEGAL SUBSTITUTES SECTION

N1.4.1 **[Required]** Record using **S3.12;**

a. Use line-up sheet and notepad from N1.2.2.a to assist recording.

N1.4.2 The Liberos are not **Legal Substitutes.**

N1.4.3 Manage **Legal Substitutes** using **S9.6.3.**

ASSISTANT SCORER RESPONSIBILITIES

Diagram 3



Libero Control Sheet

(A) SP

Libero	L	R
--------	---	---

TEAM NAME

I		
II		
III	PLAYER	
IV		
V		
VI		

(B) SP

Libero	L	R
--------	---	---

TEAM NAME

I		
II		
III	PLAYER	
IV		
V		
VI		

(A) SP

Libero	L	R
--------	---	---

I		
II		
III		
IV		
V		
VI		

(B) SP

Libero	L	R
--------	---	---

I		
II		
III		
IV		
V		
VI		

AcrB

() SP

I		
II		
III	LEFT	
IV		
V		
VI		

() SP

Libero	L	R
--------	---	---

I		
II		
III	MIDDLE	
IV		
V		
VI		

() SP

I		
II		
III	RIGHT	
IV		
V		
VI		

Enter the Libero number(s) in the Libero boxes and starting players' numbers in the SP column.
 When the Libero enters, write L or R, showing which Libero entered, next to the exiting player's number.
 When the Libero leaves, write the returning player's number or L or R if replaced by the other Libero.
 If a regular sub occurs, slash the player number and enter the new number.
 If a libero serves, place a triangle around the Roman numeral for that service position.

IV | 6 | L 6 | L 6 | 21 | L R | 21 6

LCS_150715_08/01/2015, Copyright 2015, USA Volleyball, ric.usav@all-vball.net

A1 TERMINOLOGY

A1.1 ACTING LIBERO

The Libero on the court.

A1.2 SECOND LIBERO

The Libero (if two (2) are designated) that is not on the court.

A1.3 THE L LIBERO

The Libero recorded on the line-up sheet in the first Libero box.

A1.4 THE R LIBERO

The second Libero, if recorded on the line-up sheet, in the second Libero box.

A1.5 RALLY

A sequence of playing actions from the moment of the service hit by the server until the ball is out of play. 6.1.3

A1.6 COMPLETED RALLY

The sequence of playing actions which results in the award of a point. 6.1.3

This includes the award of a penalty and loss of service for serving faults outside the time limit.

A1.7 LIBERO REPLACEMENT

A1.7.1 When the Libero replaces a regular player in the back row. 19.3.2

A1.7.2 When the Acting Libero is replaced on the court by the: 19.3.2.2

- a. The regular replacement player in that position;
- b. The second Libero.

A2 LIBERO REPLACEMENTS

A2.1 CHARACTERISTICS

A2.1.1 Libero replacements:

- a. Are not counted as substitutions. 19.3.2
- b. Are unlimited.

c. Can take place:

- 1) At the start of each set; 19.3.2.1
- 2) While the ball is out of play and before the whistle for service. 19.3.2.3

A2.1 LIMITATIONS		
A2.1.1	At the start of each set, the Libero may not enter the court until authorized by the 2 nd referee. a. Either Libero, L or R , may enter the set.	19.3.2.3
A2.1.2	The regular replacement player must be the regular player originally replaced by the Libero.	19.3.2.2
A2.1.3	There must be a completed rally between two Libero replacements unless :	19.3.2.1
	a. A penalty causes the team to rotate and the Libero moves to position four (left front);	19.3.2.1
	b. The Acting Libero becomes unable to play;	
	c. In one rotation, the Libero can replace the player in position one (right back) and serve the next rally.	USAV 19.3.2.1
A2.2 ILLEGAL REPLACEMENTS		
A2.2.1	An illegal Libero replacement can involve (amongst others):	19.3.2.9
	a. No completed rally between replacements;	
	b. The Libero being replaced by a player other than:	
	1) The second Libero;	
	2) The regular replacement player (the regular player originally replaced by the Libero).	
A2.2.2	Illegal Libero replacements are considered in the same way as an illegal substitution.	19.3.2.9
	a. If noticed before the next rally:	
	1) It is corrected by the referees;	
	2) The team is sanctioned for delay.	
	b. Is noticed after the service hit:	
	1) Treated the same as an illegal substitution.	15.9
A3 LIBERO REDESIGNATIONS		19.4
A3.1 TEAMS WITH ONE LIBERO		19.4.2
A3.1.1	If this Libero becomes unable to play:	19.4.1
	a. The coach or captain may re-designate, as Libero, any other player (replacement player excepted) not on the court at the moment of the re-designation.	19.4.2.1

A4 ASSISTANT SCORER DUTIES

A4.1 USE THE LIBERO CONTROL SHEET TO:

- A4.1.1 Identify each team's designated Liberos;
- A4.1.2 Verify that Libero replacements are legal;
- A4.1.3 Record Libero replacements;
- A4.1.4 Record substitutions;
- A4.1.5 Verify that the correct players return to court after time outs and after the court change in deciding sets;
- A4.1.6 Identify which Libero (**L** or **R**) is the Acting Libero.

A4.2 COMMUNICATE WITH SCORER AND 2ND REFEREE

- A4.2.1 Immediately notify 2nd referee if an illegal Libero replacement occurs.
 - a. If possible, as soon as it occurs to prevent further consequences;
 - b. As soon as the replacement is discovered to be illegal.
- A4.2.2 After time outs and the court change in deciding sets:
 - a. Signal the 2nd referee whether each team's Libero is on or off the court.
 - b. Using the hand corresponding to the court (left hand for the **left** court, right hand for the **right** court):
 - 1) If the Libero is **on the court**, hold the hand over the table with the palm facing down;
 - 2) If the Libero is **off the court**, hold the hand up with the palm facing the shoulder.
- A4.2.3 When requested by the 2nd referee:
 - a. Identify which libero (**L** or **R**) is on the court for a team that has two (2) designated Liberos.

A4.3 GAME CAPTAIN TRACKING

- A4.3.1 **Starting in 2015-2016**
It is not required to track the game captain or changes of the game captain.

A5 USING THE LIBERO CONTROL SHEET

A5.1 TEAM NAMES AND LINE-UPS

A5.1.1 Record the team names next to the appropriate **A** and **B** designations for **Sets 1** and **2** (consistent with the score sheet).

		Libero		
A	SP	L	R	COBRAS
I	15			
II	8			
III	10			
IV	47			
V	23			
VI	2			

A5.1.2 Record the starting line-up for each team in the Starting Players column (**SP**).

A5.2 LIBEROS

A5.2.1 When a team designates two Libereros on the **Set 1 Line-up Sheet** they are designated for the match.

a. Record the two numbers in the **L & R** Libero boxes ***for all non-deciding sets.***

Set 1

		Libero	
A	SP	L	R
		11	3

Set 2

		Libero	
A	SP	L	R
		11	3

A5.2.2 When a team designates one Libero on the **Set 1 Line-up Sheet**:

- The team may designate zero or one Libero for each remaining set of the match;
- Record the number in the **L** box for ***Set 1 only.***
- Draw an 'X' in the **R** box ***for all non-deciding sets.***

Set 1

		Libero	
B	SP	L	R
		7	X

Set 2

		Libero	
B		L	R
			X

- Before each set, record the Libero number (from the **Line-up Sheet**) or an 'X' (if zero Libero is designated) in **L** box ***for this set only.***

A5.2.3 When a team designates one Libero on the **Set 1 Line-up Sheet**:

- The team may designate zero or one Libero for each remaining set of the match;
- Draw an 'X' in the **L** box **for Set 1 only**.
- Draw an 'X' in the **R** box **for all non-deciding sets**.

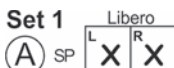

Set 2



- Before each set, record the Libero number (from the **Line-up Sheet**) or an 'X' (if zero Libero is designated) in **L** box **for this set only**.

A5.3 RECORDING LIBERO REPLACEMENTS

A5.3.1 Slashes are never used to record Libero replacements.

A5.3.2 Write an **L** or **R** next to the replaced regular player number or Acting Libero letter to designate which Libero entered the court as a replacement.

A5.3.3 When the replacement regular player returns to the court:

- Write the player number next to the **L** or **R**.

I	15	L 15
II	8	
III	6	
IV	47	L R 47
V	23	
VI	2	

A5.4 RECORDING SUBSTITUTIONS

A5.4.1 Slash through the exiting player number.

A5.4.2 Record the substitute player number immediately to the right.

I	15	L 15
II	8	
III	6	
IV	47	L R 47
V	23 23	
VI	2	

A5.5 LIBERO SERVING

A5.5.1 Record the first time a libero serves in each set.

- a. Draw a triangle around the position number (the Roman numeral) in the Service

Libero

(B)	SP	L 9	R X
-----	----	--------	--------

I	2	
△	8	L
III	10	

Order area of the **Libero Control Sheet**.

A5.6 LIBERO REDESIGNATION

A5.6.1 When the Libero is re-designated;

- a. Circle the appropriate number in the **Libero** box:
- b. Record the number of the new re-designated Libero next to or above the circled number(s).

Libero

(B)	SP	9	4	EA
-----	----	---	---	----

I	2	
II	8	
III	6 10	6
IV	32	
V	23	L 23
VI	7	14 7

A5.6.2 When two Liberos were designated at the start of the match:

- a. Repeat these actions for the remaining non-deciding sets in the match.

A5.7 DECIDING SET PREPARATION

A5.7.1 **Information**

- a. For the team starting on the **left** court:
- 1) Record all information on both the **LEFT** and **RIGHT** sections.
- b. For the team starting on the **right** court:
- 1) Record all information on the **MIDDLE** section.

A5.7.2 **After The Coin Toss:**

- a. Record the team **A/B** designation from set 1 in the **A/B** circle:
- 1) For a one (1) set playoff:
 - i. The team starting on the **left** court will be designated Team **A**;
 - ii. The team starting on the **right** court will be designated Team **B**;
- b. Record the Team Name.

A5.7.3 After The Line-Ups Are Submitted:

- a. Record the starting Line-Ups;
- b. Record the Libero numbers.

AorB (A) SP	Libero L R 2 X	COBRAS	AorB (B) SP	Libero L R 16 20	EAGLES	AorB (A) SP	COBRAS
I	18		I	3		I	18
II	47		II	1		II	47
III	6		III	14		III	6
IV	23		IV	5		IV	23
V	11		V	7		V	11
VI	15		VI	9		VI	15

A5.8 DECIDING SET – LIBERO SERVING

- A5.8.1 The first time the Libero serves in the set:
- a. Record a triangle around the appropriate position number in the Service Order area.
- A5.8.2 Libero Serving on team starting on **left** court:
- a. If the first serve occurs before the court change:
 - 1) Record the triangle on both the **LEFT** and **RIGHT** sections.
 - b. If the first serve occurs after the court change:
 - 1) Record the triangle on the **RIGHT** section **only**.

AorB (A) SP	Libero L R 3 22	SILVER	AorB (B) SP	Libero L R 9 X	BLUE	AorB (A) SP	SILVER
I	5		I	2		I	5
II	17	L	II	8		II	17
III	1		III	10		III	1
IV	9		IV	12		IV	9
V	4		V	4		V	4
VI	2		VI	1		VI	2

A5.9 DECIDING SETS – SUBSTITUTIONS

- A5.9.1 For the team beginning on the **right** court and finishing on the **left** court:
- a. Record all substitutions on the **MIDDLE** section **only**.
- A5.9.2 For the team beginning on the **left** court and finishing on the **right** court:
- a. **Before the court change:**
 - 1) Record all substitutions, **as they occur**, on the **LEFT** section;
 - 2) Record all substitutions, **as they**

occur, on the **RIGHT** section.

- b. **After the court change:**
 1) Record all substitutions on the **RIGHT** section **only**.

A5.10 DECIDING SET – LIBERO REPLACEMENTS

- A5.10.1 For the team beginning on the **right** court and finishing on the **left** court:
 a. Record all replacements on the **MIDDLE** section.
- A5.10.2 For the team beginning on the **left** court and finishing on the **right** court:
 a. **Before the court change:**
 1) Record all replacements on the **LEFT** section;
 b. **After the court change:**
 1) Record all replacements on the **RIGHT** section **only**.

SUBSTITUTIONS AND REPLACEMENTS BEFORE COURT CHANGE

AcrB B _{SP}		Libero L R 16 20	EAGLES	AcrB A _{SP}	Libero L R 5 X	COBRAS	AcrB B _{SP}	EAGLES		
I	3			I	18	L		I	3	
II	X	22	RL	II	47	8		II	X	22
III	14	4		III	6			III	14	4
IV	5			IV	12			IV	5	
V	7	L	7	V	4			V	7	
VI	9			VI	1			VI	9	

A5.11 AT COURT CHANGE

- A5.11.1 No Libero replacements can occur until after the court change.
- A5.11.2 If the Libero is on the court for the team changing courts (from **left** to **right** court):
 a. Record the letter of the Acting Libero from the **LEFT** section onto the **RIGHT** section, in the corresponding position.

AcrB B _{SP}		Libero L R 16 20	EAGLES	AcrB A _{SP}	Libero L R 5 X	COBRAS	AcrB B _{SP}	EAGLES			
I	3			I	18	L		I	3		
II	X	22	RL	II	47	8		II	X	22	L
III	14	4		III	6			III	14	4	
IV	5			IV	12			IV	5		
V	7	L	7	V	4			V	7		
VI	9			VI	1			VI	9		

A5.12 AFTER COURT CHANGE

A5.12.1 The **LEFT** section is no longer used.

A5.12.2 For the team now on the **left** court:

- Record all substitutions and replacements on the **MIDDLE** section **only**.

A5.12.3 For the team now on the **right** court:

- Record all substitutions and replacements on the **RIGHT** section **only**.

AorB B SP		Libero L R		EAGLES		AorB A SP		Libero L R		COBRAS		AorB B SP		EAGLES	
I	3							I	18	L	18				
II	1	22	RL					II	4	7	8			II	1 22 L 22
III	14	4						III	6					III	14 4
IV	5							IV	12					IV	5 8
V	7	L	7					V	4					△ 7	R
VI	9							△ 1	L					VI	9

ACTIONS AFTER COURT CHANGE

A5.13 POST MATCH PROCEDURES

A5.13.1 Before leaving the Scorer Table:

- Remove all personal items;
- Discard all trash.

S18.4

Diagram 6



Libero Control Sheet

A SP

Libero	
L	R

I		
II		
III		
IV		
V		
VI		

B SP

Libero	
L	R

I		
II		
III		
IV		
V		
VI		

A SP

Libero	
L	R

I		
II		
III		
IV		
V		
VI		

B SP

Libero	
L	R

I		
II		
III		
IV		
V		
VI		

A or B SP

Libero	
L	R

I		
II		
III		
IV		
V		
VI		

SP

Libero	
L	R

I		
II		
III		
IV		
V		
VI		

SP

I		
II		
III		
IV		
V		
VI		

Enter the Libero number(s) in the Libero boxes and starting players' numbers in the SP column.
 When the Libero enters, write L or R, showing which Libero entered, next to the exiting player's number.
 When the Libero leaves, write the returning player's number or L or R if replaced by the other Libero.
 If a regular sub occurs, slash the player number and enter the new number.
 If a libero serves, place a triangle around the Roman numeral for that service position.

IV	6	L	6	L	Ø	21	L	R	21	6
----	---	---	---	---	---	----	---	---	----	---

SCORING EXAMPLE
Non-Deciding Set
(Step by Step)

INFORMATION	ACTION
USE BLUE/BLACK INK	
<p>E1 PRE-MATCH</p> <p>Name: 2015 USAV Open Championships</p> <p>City, St: Jefferson City, Mo. Hall: Jeff City Truman Hall</p> <p>Date: June 7, 2015 Match Time: 4:10 PM Court: 15</p> <p>Set 1</p> <p>Match Info: Adult Men's 60s Pool: R2M6P4 Match: 3</p> <p>Teams: <u>Wizards of Emerald City</u> <u>Lost Boys of Neverland</u></p> <p>1st Referee: Jane Doe 2nd Referee: Jax Smith Scorer: Sam Uncle Work Team: Tin Men Region: OZ</p>	<p style="text-align: center; background-color: #e0e0e0;">SCORER</p> <p>If not pre-printed,</p> <ol style="list-style-type: none"> 1. Record all HEADINGS. 2. Record 1 in Set box. 3. Record OFFICIALS' PRINTED NAMES. 4. Record Work Team and Region two-letter code. <p>Notes and Hints</p> <p>Use all CAPITAL LETTERS;</p> <p>In vs box: Use Team's Full Names;</p> <p>All officials' names are recorded as Last_Name, First_Name;</p> <p>Shortened Team Names: WIZARDS and LOST BOYS,</p>
<p>E2 RESULTS OF COIN TOSS</p> <p>LOST BOYS Receiving from left court;</p> <p>WIZARDS Serving from right court;</p> <p>NOTE: Teams alternate courts for all non-deciding sets.</p>	<p style="text-align: center; background-color: #e0e0e0;">SCORER</p> <ol style="list-style-type: none"> 1. Record: <ol style="list-style-type: none"> a. LOST BOYS in Team Info section on left side. b. WIZARDS in Team Info section on right side. <p>If not pre-printed,</p> <ol style="list-style-type: none"> 2. Record in A/B circles: <ol style="list-style-type: none"> a. A next to LOST BOYS; b. B next to WIZARDS. 3. Record this information on all non-deciding set score sheets. <ol style="list-style-type: none"> a. Alternate Sides Of SCORE SHEET For Each Set.

INFORMATION

ACTION

E2 RESULTS OF COIN TOSS
Continued
LOST BOYS
 Receiving from **left** court;

WIZARDS
 Serving from **right** court;

SCORER

- Record **X** through:
 - The **(R)** for **LOST BOYS**;
 - The **(S)** for **WIZARDS**.
- Record **X** in **LOST BOYS Service Rounds**, column **I**, box **1**.
- Record serving and receiving information on all non-deciding set score sheets.

Serve And Receive Remain On Same Side Of SCORE SHEET.

ASSISTANT SCORER
 Will Record Information On **LIBERO CONTROL SHEET**

For all non-deciding sets:

- Record **LOST BOYS** next to **Libero** boxes for team **A**;
- Record **WIZARDS** next to **Libero** boxes for team **B**;

E3 ROSTERS

LOST BOYS: 9 Team Captain;

WIZARDS: No captain indicated;

SCORER

Above LOST BOYS

- Record **9** in **CAPTAIN** box.

Above WIZARDS

- Record **X** in **CAPTAIN** box.

E4 LOST BOYS LINE-UP SHEET

SET 1		LIBERO
LINE-UP SHEET		Nº
TEAM LOST BOYS	11	X

IV 47	III 10c	II 8
V 23	VI 2	I 15

SERVICE

COACH SIGNATURE

Lostboys Boss

SCORER

Next to LOST BOYS
 In **Libero#** boxes:

- Record:
 - 11** in first box;
 - X** in second box.

For LOST BOYS: On the LINE-UP SHEET and all remaining non-deciding set score sheets:

- Record **X** in second box.

Below LOST BOYS

- Record line-up in **SERVICE ORDER** section.

INFORMATION

ACTION

E4 LOST BOYS
LINE-UP SHEET
Continued

SET 1		LIBERO
LINE-UP SHEET		N°
TEAM	LOST BOYS	11 X
IV	III	II
47	10c	8
V	VI	I
23	2	15
		SERVICE
COACH SIGNATURE		
Lostboys Boss		

SCORER
Above LOST BOYS 4. Record captain: a. 10 in CAPTAIN circle,
ASSISTANT SCORER
For LOST BOYS <u>For Set 1 only:</u> 5. Record Liberos: a. 11 in L box; b. X in R box. <u>On all non-deciding sets:</u> 6. Record X in R box. 7. Record the starting line-up in the SP column.

Note: LOST BOYS can choose a different Libero for each set.

E5 WIZARDS
LINE-UP SHEET

SET 1		LIBERO
LINE-UP SHEET		N°
TEAM	WIZARDS	6c 20
IV	III	II
14	1	3
V	VI	I
5a	7	9
		SERVICE
COACH SIGNATURE		
Wizard Leader		

SCORER
Next to WIZARDS 1. Record, in Libero# boxes: a. 6 in first box; b. 20 in second box. For WIZARDS: <u>On the LINE-UP SHEET and all remaining non-deciding set score sheets:</u> 2. Record: a. 6 in first box; b. 20 in second box. Below WIZARDS 3. Record line-up in the SERVICE ORDER section. Above WIZARDS 4. Record team captains: a. 6 in CAPTAIN circle: b. 5 in first slot.

The Libero **6** is the team captain, when on the court.

The **alternate** team captain is **5** and will assume the duties of the team captain when Libero **6** is not on the court.

ASSISTANT SCORER
For WIZARDS 5. Record Liberos for Set 1: a. 6 in L box; b. 20 in R box; <u>On all non-deciding sets:</u> 6. Record: a. 6 in L box; b. 20 in R box;

INFORMATION

ACTION

Libero (A) SP <table border="1" style="display: inline-table; vertical-align: middle;"><tr><td style="width: 20px;">L</td><td style="width: 20px;">11</td><td style="width: 20px;">R</td><td style="width: 20px;">X</td></tr></table> LOST BOYS	L	11	R	X	Libero (B) SP <table border="1" style="display: inline-table; vertical-align: middle;"><tr><td style="width: 20px;">L</td><td style="width: 20px;">6</td><td style="width: 20px;">R</td><td style="width: 20px;">20</td></tr></table> WIZARDS	L	6	R	20
L	11	R	X						
L	6	R	20						
I 15	I 9								
II 8									
III 10	III 1								
IV 47	IV 14								
V 23	V 5								
VI 2	VI 7								

E6 RECOMMENDED SUBSTITUTION PROCEDURE

ROSTERS ARE NOT USED AT ALL EVENTS

Required For National Scorers

4	1	4	Time Outs	Time Outs	1	4
5	2	5			2	5
LOST BOYS			WIZARDS			
6	3	6	:	:	3	6
9 17			4 22			

SCORER

After comparing the rosters and line-up sheets:

The **Legal Substitutes** are:

LOST BOYS: 9, 17

WIZARDS: 4, 22

1. Record each team's legal substitutes in **Legal Substitutes** section.
2. Use recorded **Legal Substitutes** to confirm the substitute (incoming) is legal.

E7 CHECKING LINE-UPS

While checking the **WIZARDS** line-up, the 2nd referee and scorer notice that **WIZARDS 4** is on the court instead of **14**.

WIZARDS 14 is **NOT** present court side.

WIZARDS request a substitution **4** for **14**.

SCORER

For WIZARDS

In **Legal Substitutes** section:

1. Confirm substitute is legal;
2. Slash through **4** to indicate that **4** has entered the court;

In **Score at Substitutions** column **IV**, first row under **14**:

3. Record **4** in left box;
4. Record **0:0** (score) in right box;

In Substitutions row:

5. Slash through **1**.

ASSISTANT SCORER

In **WIZARDS PLAYER** section:

6. Slash through **14**.
7. Record **4** next to **14**.

INFORMATION	ACTION
<p>E8 LIBERO REPLACEMENT</p> <p>After 2nd referee and scorer check WIZARDS line-up, WIZARDS Libero 6 replaces 7.</p> <p>After 2nd referee and scorer check LOST BOYS line-up, LOST BOYS Libero 11 replaces 23.</p>	<p>ASSISTANT SCORER</p> <p>In WIZARDS PLAYER section:</p> <ol style="list-style-type: none"> Record L next to 7; <ol style="list-style-type: none"> Do not slash through 7. <p>In LOST BOYS PLAYER section:</p> <ol style="list-style-type: none"> Record L next to 23; <ol style="list-style-type: none"> Do not slash through 23.
<p>E9 DELAY WARNING</p> <p>After 2nd referee checks LOST BOYS line-up, LOST BOYS 2 goes to the bench to fix jersey.</p> <p>1st referee issues a delay warning.</p>	<p>SCORER</p> <p>In first row of SANCTIONS box:</p> <ol style="list-style-type: none"> Record: <ol style="list-style-type: none"> D in W Warn column; A in A/B column; 1 in SET column; 0:0 in SCORE column.
<p>E10 LINE-UP CHECKS DONE</p> <p>2nd referee and scorer have completed line-up checks for both teams.</p>	<p>SCORER & ASSISTANT</p> <ol style="list-style-type: none"> Make eye contact with 2nd referee. Show Ready signal. <p>SCORER</p>
<p>E11 FIRST SERVICE</p> <p>At 4:10 PM, 1st referee beckons for serve.</p>	<p>In Start TIME box:</p> <ol style="list-style-type: none"> Record 16:10.
USE PENCIL OR BLUE/BLACK INK	
<p>E12 WIZARDS SERVICE</p> <p>WIZARDS 9 contacts the ball;</p> <p>Ball lands out of bounds;</p>	<p>SCORER</p> <p>In WIZARDS Service Rounds Column I, Box 1, under 9:</p> <ol style="list-style-type: none"> Draw small checkmark (✓) through 1 in upper right corner; Record Exit Score 0 in the box. <p>In LOST BOYS Points column:</p> <ol style="list-style-type: none"> Slash through <u>rally point</u> 1.
<p>E13 LOST BOYS ROTATE</p> <p>LOST BOYS 23 replaces Libero;</p>	<p>ASSISTANT SCORER</p> <p>In LOST BOYS PLAYER section:</p> <ol style="list-style-type: none"> Record 23 next to L. <ol style="list-style-type: none"> Do not slash through L.

INFORMATION	ACTION
<p>E14 LOST BOYS SERVICE</p> <p>LOST BOYS 8 contacts the ball;</p> <p>Wins point; Serves an ace; Wins another point; Serves into net;</p>	<p>SCORER</p> <p>In LOST BOYS Service Rounds column II, box 1, under 8:</p> <ol style="list-style-type: none"> 1. Draw small checkmark (✓) through 1 in upper right corner. <p>In LOST BOYS Points column:</p> <ol style="list-style-type: none"> 2. Slash through 2; 3. Slash through 3; 4. Slash through 4; 5. Record Exit Score 4. 6. Slash through WIZARDS rally point 1.
<p>E15 WIZARDS SERVICE</p> <p>WIZARDS 3 contacts ball;</p> <p>LOST BOYS shank ball and lose point; WIZARDS 3 serves two aces; WIZARDS win next point on a close lines call;</p> <p>LOST BOYS 10 complains loudly about call and is given a verbal warning; WIZARDS 3 serves a point;</p>	<p>SCORER</p> <p>In WIZARDS Service Rounds column II, box 1, under 3:</p> <ol style="list-style-type: none"> 1. Draw a small checkmark (✓) through 1 in the right corner. <p>In WIZARDS Points column:</p> <ol style="list-style-type: none"> 2. Slash through 2; 3. Slash through 3, 4; 4. Slash through 5; 5. No action required; 6. Slash through 6.
<p>E16 SUBSTITUTION</p> <p>LOST BOYS substitute 17 for 15;</p>	<p>SCORER</p> <p>In LOST BOYS Legal Substitute section:</p> <ol style="list-style-type: none"> 1. Confirm substitute is legal; 2. Slash through 17; <p>In LOST BOYS Score at Substitution row under 15:</p> <ol style="list-style-type: none"> 3. Record 17 in left box; 4. Record 4:6 (score) in right box; <p>In LOST BOYS Substitutions row:</p> <ol style="list-style-type: none"> 5. Slash through 1. 6. Show READY signal.

INFORMATION	ACTION
<p>E16 SUBSTITUTION Continued LOST BOYS substitute 17 for 15;</p>	<p>ASSISTANT SCORER</p> <p>In LOST BOYS PLAYER section:</p> <ol style="list-style-type: none"> 7. Slash through 15. 8. Record 17 next to 15.
<p>E17 MISCONDUCT WARNING YELLOW CARD LOST BOYS 10 continues complaining about ball handling and line calls. The 1st referee issues a Misconduct Warning (Yellow Card).</p>	<p>SCORER</p> <p>In the next SANCTIONS box:</p> <ol style="list-style-type: none"> 1. Record: <ol style="list-style-type: none"> a. 10 in W Warn column; b. A in A/B column; c. 1 in SET column; d. 4:6 in SCORE column. 2. Show READY signal.
<p>E18 TIME OUT LOST BOYS take 1st time out.</p>	<p>SCORER</p> <p>In first Time Out box under LOST BOYS Points column:</p> <ol style="list-style-type: none"> 1. Record 4:6 (score). 2. Show 2nd referee number of time outs taken by each team. <p>At end of time out:</p> <ol style="list-style-type: none"> 3. Show READY signal.
<p>E19 WIZARDS CONTINUE TO SERVE WIZARDS 3 serves into the net.</p>	<p>SCORER</p> <ol style="list-style-type: none"> 1. Record WIZARDS exit score 6. 2. Record LOST BOYS <i>rally point</i> 5.
<p>E20 SUBSTITUTION</p> <p>LOST BOYS substitute 9 for 47.</p>	<p>SCORER</p> <p>In LOST BOYS Legal Substitute section:</p> <ol style="list-style-type: none"> 1. Confirm substitute is legal; 2. Slash through 9; <p>In LOST BOYS Score at Substitution row under 47:</p> <ol style="list-style-type: none"> 3. Record 9 in left box; 4. Record 5:6 (score) in right box; 5. Notify 2nd referee that the captain is 9. <p>In LOST BOYS Substitutions row:</p> <ol style="list-style-type: none"> 6. Slash through 2. 7. Show READY signal.

INFORMATION	ACTION
<p>E20 SUBSTITUTION Continued</p> <p>LOST BOYS substitute 9 for 47.</p>	<p>ASSISTANT SCORER</p> <p>In LOST BOYS PLAYER section:</p> <p>8. Record 9 next to 47; a. Slash through 47.</p>
<p>E21 LOST BOYS SERVICE</p> <p>LOST BOYS 9 contacts the ball; Wrong Server</p> <p>LOST BOYS 10 is correct server.</p>	<p>SCORER</p> <p>1. Notify 2nd referee of the wrong server.</p> <p>In LOST BOYS Service Rounds column III, box 1, under 10:</p> <p>2. Do Not draw small checkmark (✓) through 1 in upper right corner.</p> <p>3. Record Exit Score 5.</p> <p>4. Slash through WIZARDS rally point 7.</p>
<p>E22 WIZARDS ROTATE</p> <p>WIZARDS substitute 22 for 1.</p> <p>WIZARDS 7 replaces Libero.</p>	<p>SCORER</p> <p>In WIZARDS Legal Substitute section:</p> <p>1. Confirm substitute is legal; 2. Slash through 22;</p> <p>In WIZARDS Score at Substitution row under 1:</p> <p>3. Record 22 in left box; 4. Record 7:5 (score) in right box;</p> <p>In WIZARDS Substitutions row:</p> <p>5. Slash through 2. 6. Show READY signal.</p> <p>ASSISTANT SCORER</p> <p>In WIZARDS PLAYER section:</p> <p>7. Slash through 1. 8. Record 22 next to 1; 9. Record 7 next to L. a. Do not slash through L.</p>
<p>E23 WIZARDS SERVICE</p> <p>WIZARDS 22 contacts the ball.</p> <p>WIZARDS 22 serves five points.</p>	<p>SCORER</p> <p>In WIZARDS Service Rounds column III, box 1, under 22:</p> <p>1. Draw small checkmark (✓) through 1 in upper right corner.</p> <p>In LOST BOYS Points column:</p> <p>2. Slash through 8 - 12;</p>

INFORMATION	ACTION
E23 WIZARDS SERVICE Continued WIZARDS 22 serves and loses the point.	SCORER
	3. Record WIZARDS exit score 12 . 4. Slash through LOST BOYS rally point 6 .
E24 LIBERO REPLACEMENT WIZARDS Libero 20 replaces 22 .	ASSISTANT SCORER
	In WIZARDS PLAYER section: 1. Record R next to 22 ; a. Do not slash through 22 .
E25 LOST BOYS SERVICE LOST BOYS 9 serves and loses the point.	SCORER
	In LOST BOYS Service Rounds column IV , box 1 , under 9 : 1. Draw small checkmark (✓) through 1 in upper right corner. 2. Record LOST BOYS Exit Score 6 . 3. Slash through WIZARDS rally point 13 .
E26 WIZARDS SERVICE WIZARDS 4 contacts the serve. WIZARDS score 2 points. WIZARDS lose the next rally.	SCORER
	In WIZARDS Service Rounds column IV , box 1 , under 4 : 1. Draw small checkmark (✓) through 1 in upper right corner. In WIZARDS Points column: 2. Slash through 14, 15 . 3. Record WIZARDS Exit Score 15 . 4. Slash through LOST BOYS rally point 7 .
E27 SUBSTITUTION WIZARDS substitute 14 for 4 .	SCORER
	In WIZARDS Score at Substitution row under 4 : 1. Record 14 in left box; 2. Record 15:7 (score) in right box; In WIZARDS Substitutions row: 3. Slash through 3 . 4. Show READY signal.

INFORMATION	ACTION
<p>E28 LOST BOYS SERVICE</p> <p>LOST BOYS 23 contacts ball.</p> <p>LOST BOYS lose rally.</p>	<p style="text-align: center;">SCORER</p> <p>In LOST BOYS Service Rounds column V, box 1, under 23:</p> <ol style="list-style-type: none"> 1. Draw small checkmark (✓) through 1 in upper right corner. 2. Record LOST BOYS Exit Score 7. 3. Slash through WIZARDS rally point 16.
<p>E29 LIBERO REPLACEMENT</p> <p>LOST BOYS Libero 11 replaces 23.</p>	<p style="text-align: center;">ASSISTANT SCORER</p> <p>In LOST BOYS PLAYER section:</p> <ol style="list-style-type: none"> 1. Record L next to 23; <ol style="list-style-type: none"> a. Do not slash through 23.
<p>E30 WIZARDS SERVICE</p> <p>WIZARDS 5 contacts serve.</p> <p>WIZARDS lose rally.</p>	<p style="text-align: center;">SCORER</p> <p>In WIZARDS Service Rounds column V, box 1, under 5:</p> <ol style="list-style-type: none"> 1. Draw small checkmark (✓) through 1 in upper right corner. <p>In WIZARDS Points column:</p> <ol style="list-style-type: none"> 2. Record WIZARDS Exit Score 16. 3. Slash through LOST BOYS rally point 8.
<p>E31 LIBERO REPLACEMENT</p> <p>LOST BOYS Libero 11 goes back to serve.</p>	<p style="text-align: center;">ASSISTANT SCORER</p> <p>In LOST BOYS PLAYER section:</p> <ol style="list-style-type: none"> 1. Record 23 next to L; <ol style="list-style-type: none"> a. Do not slash through L. 2. Record L next to 2; <ol style="list-style-type: none"> a. Do not slash through 2.
<p>E32 LIBERO SERVING</p> <p>LOST BOYS Libero contacts ball.</p>	<p style="text-align: center;">SCORER</p> <p>In LOST BOYS SERVICE ORDER</p> <ol style="list-style-type: none"> 1. Draw a triangle around VI. <p style="text-align: center;">ASSISTANT SCORER</p> <p>On LOST BOYS side:</p> <ol style="list-style-type: none"> 2. Draw a triangle around VI.

INFORMATION	ACTION
<p>E32 LIBERO SERVING Continued</p> <p>LOST BOYS score two points.</p> <p>LOST BOYS lose next rally.</p>	<p>SCORER</p> <p>In LOST BOYS Service Rounds column VI, box 1, under 2:</p> <p>3. Draw small checkmark (✓) through 1 in upper right corner.</p> <p>In LOST BOYS Points column:</p> <p>4. Draw triangle around 9, 10.</p> <p>5. Record LOST BOYS Exit Score 10.</p> <p>6. Slash through WIZARDS rally point 17.</p>
<p>E33 WIZARDS SERVICE</p> <p>After the beckon, WIZARDS 4 runs into the substitution zone. The 2nd referee waves 4 back without a whistle.</p> <p>WIZARDS 7 contacts serve.</p> <p>WIZARDS win rally.</p> <p>Improper Request 2nd referee notifies scorer of the WIZARDS Improper Request.</p>	<p>SCORER</p> <p>In WIZARDS Service Rounds column VI, box 1, under 7:</p> <p>1. Draw small checkmark (✓) through 1 in upper right corner.</p> <p>In WIZARDS Points column:</p> <p>2. Slash through 18.</p> <p>In the IMPROPER REQUEST section:</p> <p>3. Draw an X through the TEAM B circle.</p>
<p>E34 LOST BOYS TIME OUT</p> <p>LOST BOYS take 2nd time out.</p>	<p>SCORER</p> <p>In second Time Out box under LOST BOYS Points column:</p> <p>1. Record 10:18 (score).</p> <p>2. Show 2nd referee number of time outs taken by each team.</p> <p>At end of time out:</p> <p>3. Show READY signal.</p>
<p>E35 DELAY SANCTION</p> <p>After the time out, LOST BOYS take additional time (1 minute) to clean a water spill on the court. The 1st referee issues a delay sanction.</p> <p>During the confusion WIZARDS 22 goes to the bench and WIZARDS 1 enters the court. A WRONG PLAYER is on the court and goes undetected by the 2nd referee and scorer.</p>	<p>SCORER</p> <p>In next row of SANCTIONS box:</p> <p>1. Record in the columns listed:</p> <p>a. D P-Penalty;</p> <p>b. A A/B;</p> <p>c. 1 SET;</p> <p>d. 10:18 SCORE.</p> <p>In WIZARDS Points column:</p> <p>2. Slash and circle delay penalty point 19.</p>

INFORMATION	ACTION
<p>E36 WIZARDS CONTINUE SERVING</p> <p>WIZARDS 7 serves an ace. WIZARDS 7 serves into the net.</p>	<p style="text-align: center;">SCORER</p> <p>In WIZARDS Points column:</p> <ol style="list-style-type: none"> 1. Slash through 20. 2. Record WIZARDS Exit Score 20. 3. Slash through LOST BOYS rally point 11.
<p>E37 LOST BOYS SERVICE</p> <p>LOST BOYS 17 contacts ball.</p> <p>LOST BOYS score three points. LOST BOYS lose next rally.</p>	<p style="text-align: center;">SCORER</p> <p>In LOST BOYS Service Rounds column I, box 2, under 17:</p> <ol style="list-style-type: none"> 1. Draw small checkmark (✓) through 2 in upper right corner. <p>In LOST BOYS Points column:</p> <ol style="list-style-type: none"> 2. Slash through 12, 13, 14. 3. Record LOST BOYS Exit Score 14. 4. Slash through WIZARDS rally point 21.
<p>E38 EXCEPTIONAL SUBSTITUTION</p> <p>During the previous rally, LOST BOYS 10 is injured and unable to continue.</p> <p>LOST BOYS players on the bench are 15, 47.</p> <p>Since both had been in the set, either can be the exceptional substitute.</p> <p>The coach chooses 47.</p>	<p style="text-align: center;">SCORER</p> <p>In LOST BOYS SERVICE ORDER, column II:</p> <ol style="list-style-type: none"> 1. Draw a circle around 10 to indicate that 10 is no longer eligible to play for the match. <p>In the same column, in the first Score at Substitution row:</p> <ol style="list-style-type: none"> 2. Record 47 in left box; 3. Do not record the score in the right box. 4. Record a remark in the REMARKS section. <p style="text-align: center;">ASSISTANT SCORER</p> <p>In the LOST BOYS PLAYER section:</p> <ol style="list-style-type: none"> 5. Draw a circle around 10; 6. Record 47 next to 10.

INFORMATION	ACTION
<p>E39 WIZARDS SERVICE</p> <p>WIZARDS 9 contacts the ball.</p> <p>WIZARDS 9 scores 3 points.</p> <p>At this point the scorer realizes that WIZARDS 1 is on the court with the score sheet having no record of WIZARDS 1 re-entering the court.</p>	<p style="text-align: center;">SCORER</p> <p>In WIZARDS Service Rounds column I, box 2, under 9:</p> <ol style="list-style-type: none"> 1. Draw small checkmark (✓) through 2 in upper right corner. <p>In WIZARDS Points column:</p> <ol style="list-style-type: none"> 2. Slash through 22, 23, 24. 3. Notify the 2nd referee of the illegal player.
<p>E40 REMOVING POINTS</p> <p>The 2nd referee and scorer discuss the illegal player.</p> <p>After discussion with the 1st referee it is determined that WIZARDS 1 entered the court during the time out.</p> <p>The score was WIZARDS 18 and LOST BOYS 10.</p> <p>The 2nd referee instructs the scorer to remove points 19 through 24 and to restore one penalty point.</p>	<p style="text-align: center;">SCORER</p> <p>In the WIZARDS Points column:</p> <ol style="list-style-type: none"> 1. Remove 19-24. If using pencil: <ol style="list-style-type: none"> a. Erase the slashes over 19-24. If using ink and correction tape: <ol style="list-style-type: none"> b. Use tape to cover 19-24; c. Reprint 19-24. Otherwise: <ol style="list-style-type: none"> d. Draw an X through 19-24. e. Print 19-24 next to each X. <p>Restore one penalty point:</p> <ol style="list-style-type: none"> 2. Slash and circle the first available point 19. 3. Record a remark in the REMARKS section. 4. Record WIZARDS Exit Score 19. 5. Record LOST BOYS rally point 15. 6. Show the READY signal.
<p>E41 LOST BOYS SERVICE</p> <p>LOST BOYS 8 contacts the ball.</p>	<p style="text-align: center;">SCORER</p> <p>In LOST BOYS Service Rounds column II, box 2, under 8:</p> <ol style="list-style-type: none"> 1. Draw small checkmark (✓) through 2 in upper right corner.

INFORMATION	ACTION
<p>E41 LOST BOYS SERVICE Continued LOST BOYS score two points. LOST BOYS lose the next rally.</p>	<p style="text-align: center;">SCORER</p> <p>In LOST BOYS Points column:</p> <ol style="list-style-type: none"> 1. Slash through 16, 17. 2. Record LOST BOYS Exit Score 17. <p>Slash through WIZARDS rally point 20.</p>
<p>E42 WIZARDS SERVICE</p> <p>WIZARDS 3 contacts the ball.</p> <p>WIZARDS 3 serves 5 points to end the set.</p>	<p style="text-align: center;">SCORER</p> <p>In WIZARDS Service Rounds column II, box 2, under 3:</p> <ol style="list-style-type: none"> 1. Draw small checkmark (✓) through 2 in upper right corner. <p>In WIZARDS Points column:</p> <ol style="list-style-type: none"> 2. Slash through 21-25. 3. Record WIZARDS Exit Score 25.
USE BLUE/BLACK INK	
<p>E43 SET END TIME</p> <p>The set ends at 4:42 PM.</p>	<p style="text-align: center;">SCORER</p> <p>In the End TIME box:</p> <ol style="list-style-type: none"> 1. Record 16:42.

**SCORER
END OF SET PROCEDURES**

E44 FINAL EXIT SCORES

In the **SERVICE ROUNDS** section:

1. Circle final **Exit Scores** for each team:
 - a. **LOST BOYS 17;**
 - b. **WIZARDS 25.**

E45 SET RESULTS

In **SET RESULTS** box:

1. Record teams (Name and Score):
 - a. **Winning WIZARDS 25;**
 - b. **Losing LOST BOYS 17.**

E46 POINTS COLUMN:

1. Cancel all unused points using the **T-Bar** method.

NOTE: Draw a separate T-Bar through each column.

E47 SCORE SHEET REVIEW

1. Examine Score sheet for Completeness and Accuracy:
 - a. **Set** number is printed (if not pre-printed);
 - b. **Start** and **End TIMES**;
 - c. Number of substitutions match in all areas;
 - d. Last point recorded in **POINTS COLUMN**;
 - e. Last exit scores entered and circled;
 - f. All unused points in **POINTS COLUMN** are cancelled using **T-Bars**;
 - g. The correct teams and scores are listed in the **RESULTS** section.

E48 SCORER SIGNATURE

In the **SIGNATURES** box:

1. Sign the score sheet when complete and accurate.
 - a. For one-up score sheets after each set;
 - b. For two-up score sheets after both sets.

SCORER
NEXT SET SCORE SHEET PREPARATION PROCEDURES

E49 RECORD INFORMATION FROM PREVIOUS SCORE SHEETS
The 2-up score sheet will have this information recorded once before the first set of each NEW 2-up score sheet begins.

If not pre-printed

1. Copy all information from **HEADINGS** section.
2. Copy all information in the **SANCTIONS** section.
3. Copy all information in the **IMPROPER REQUEST** section.
4. Copy all pertinent information in the **REMARKS** section:
 - a. Any information which affects the playing of this set such as exceptional substitutions, Libero re-designations.
5. Copy all information in the **OFFICIALS** section

Notes:

Team A from Set 1 remains team A for the entire match.
 Teams switch courts for each non-deciding set.
 For the deciding set, a coin toss is used to determine starting court for the teams.

6. Record Team Names on correct side of score sheet
7. If not pre-printed, record **A, B** in the correct **A/B** circles.
8. Record **Libero#** boxes:

If team had designated zero or one Libero in the previous set:

 - a. Draw an 'X' in the right slot of the **Libero#** box for that team.

If team had designated two Liberors in the previous set:

 - b. Copy all **Libero#** box information Draw an 'X' in the right slot of the **Libero#** box for that team.

FINISHED

COMPLETED EXAMPLE LIBERO CONTROL SHEET

(A) SP <table border="1" style="display: inline-table; vertical-align: middle;"> <tr> <td style="text-align: center;">L 11</td> <td style="text-align: center;">R X</td> </tr> </table> LOST BOYS	L 11	R X	(B) SP <table border="1" style="display: inline-table; vertical-align: middle;"> <tr> <td style="text-align: center;">L 6</td> <td style="text-align: center;">R 20</td> </tr> </table> WIZARDS	L 6	R 20
L 11	R X				
L 6	R 20				
I 18 14	I 9				
II 8	II 3				
III 10 47	III 2 22 R				
IV 4 9	IV 14 4				
V 23 L 23 L 23	V 5				
V 2 L	VI 7 L 7				

COMPLETED EXAMPLE NON-DECIDING SET SCORE SHEET

		Name of the Competition: 2015 USAV OPEN CHAMPIONSHIPS																	
City, State: JEFFERSON CITY, MO		Hall: JEFF CITY TRUMAN HALL																	
Division: Men <input checked="" type="checkbox"/> Women <input type="checkbox"/> Cadet <input type="checkbox"/>		Pool/Phase: R2M6P4																	
Category: Adult <input checked="" type="checkbox"/> Junior <input type="checkbox"/> Level: 60		Match N: 3																	
OFFICIAL SCORESHEET		WIZARDS OF EMERALD CITY vs. LOST BOYS OF NEVERLAND																	
D-Delay: A-Assist Coach IMPROPER REQUEST E-Player Trainer TEAM (A) : TEAM (X) C-Coach Washington W: W P E D (S) SET SCORE M: M P E D (S) SET SCORE S: S M P E D (S) SET SCORE T: T M P E D (S) SET SCORE I: I M P E D (S) SET SCORE O: O M P E D (S) SET SCORE N: N M P E D (S) SET SCORE A: A M P E D (S) SET SCORE D: D M P E D (S) SET SCORE		REMARKS EX SUB 47 FOR 10. A, SET 1, 14-21 ILLEGAL PLAYER ON CT. PTS 19-24 REMOVED, RESTORED 1. PENALTY POINT, EXIT SCORE 19, B, SET 1, 24-10																	
CAPTAIN 9 (10) Start 16:10 Team LOST BOYS		CAPTAIN X (6) 5 End 16:42																	
Order	I	II	III	IV	V	VI	Substitutions	1	2	3	4	5	6	7	8	9	10	11	12
Score at Substitution	17	4:6	47	9:5:6															
Service Rounds	X	4	5	6	7	10													
Points	14	5	2	5	2	5	4:6	19	25	12	15	16	20						
Time																			
Substitutions	14	17																	
Substitutions	1	2	3	4	5	6	7	8	9	10	11	12	13	14	15	16	17	18	19
Substitutions	1	2	3	4	5	6	7	8	9	10	11	12	13	14	15	16	17	18	19
Substitutions	1	2	3	4	5	6	7	8	9	10	11	12	13	14	15	16	17	18	19

Diagram 7 Deciding Set Score Sheet

8:00a = 08:00	Date
1:00p = 13:00	Court
2:00p = 14:00	Time
3:00p = 15:00	

Name of the Competition		Pool Phase	
City, State	Hall	Match N°	
Division	Men <input type="checkbox"/> Women <input type="checkbox"/>	CoEd	<input type="checkbox"/>
Category	Adult <input type="checkbox"/> Junior <input type="checkbox"/>	Level	
vs			

D=Delay A=Asst Coach #=Player T=Trainer C=Coach M=Manager	IMPROPER REQUEST TEAM (A) : TEAM (B)	W P E D A SET SCORE WarmPenalty/Expel/DisQ	TEAM MATCH WINNER Sets W L SET RESULTS Score	SIGNATURES Scorer 1st Referee 1st 2nd Scorer Work Team Region
REMARKS				

Order	Team		Libero		Points (S/R)		Points (S/R)		Points at Chg		Set			
	I	II	I	II	A	B	A	B	I	II	III	IV	V	VI
1	1	1	1	1	1	1	1	1	1	1	1	1	1	1
2	2	2	2	2	2	2	2	2	2	2	2	2	2	2
3	3	3	3	3	3	3	3	3	3	3	3	3	3	3
4	4	4	4	4	4	4	4	4	4	4	4	4	4	4
5	5	5	5	5	5	5	5	5	5	5	5	5	5	5
6	6	6	6	6	6	6	6	6	6	6	6	6	6	6
7	7	7	7	7	7	7	7	7	7	7	7	7	7	7
8	8	8	8	8	8	8	8	8	8	8	8	8	8	8
9	9	9	9	9	9	9	9	9	9	9	9	9	9	9
10	10	10	10	10	10	10	10	10	10	10	10	10	10	10
11	11	11	11	11	11	11	11	11	11	11	11	11	11	11
12	12	12	12	12	12	12	12	12	12	12	12	12	12	12
Substitutions 1 2 3 4 5 6 7 8 9 10 11 12												Substitutions 1 2 3 4 5 6 7 8 9 10 11 12		

SCORING EXAMPLE
Deciding Set
(Step by Step)

INFORMATION	ACTION
USE BLUE/BLACK INK	
<p>D1 PRE-MATCH</p> <p>Name: 2015 USAV Open Championships</p> <p>City, St: Jefferson City, Mo. Hall: Jeff City Truman Hall</p> <p>Date: June 7, 2015 Match Time: 4:10 PM Court: 15</p> <p>Set 1</p> <p>Match Info: Adult Men's 60s Pool: R2M6P4 Match: 3</p> <p>Teams: <u>Wizards of Emerald City</u> <u>Lost Boys of Neverland</u></p> <p>1st Referee: Jane Doe 2nd Referee: Jax Smith Scorer: Sam Uncle Work Team: Tin Men Region: OZ</p> <p>WIZARDS won set 1 25:17 LOST BOYS won set 2 25:20</p> <p>There were no SANCTIONS or pertinent REMARKS in set 2.</p>	<p style="text-align: center; background-color: #e0e0e0;">SCORER</p> <p>If not pre-printed,</p> <ol style="list-style-type: none"> 1. Record all HEADINGS. 2. Record 3 in Set box. 3. Record OFFICIALS' PRINTED NAMES. 4. Record Work Team and Region two-letter code. 5. Copy all SANCTIONS and any <i>pertinent</i> REMARKS from Set 1 and Set 2 to the Set 3 score sheet. It is not necessary to copy the removal of points remark from Set 1 to the Set 3 score sheet. <p>Notes and Hints</p> <p>Use all CAPITAL LETTERS;</p> <p>In vs box: Use Team's Full Names;</p> <p>All officials' names are recorded as Last_Name, First_Name;</p> <p>Shortened Team Names: WIZARDS and LOST BOYS.</p>
<p>D2 RESULTS OF COIN TOSS</p> <p>LOST BOYS Receiving from left court;</p> <p>WIZARDS Serving from right court;</p>	<p style="text-align: center; background-color: #e0e0e0;">SCORER</p> <ol style="list-style-type: none"> 1. Record: <ol style="list-style-type: none"> a. LOST BOYS in Team Info section on LEFT and RIGHT sections. b. WIZARDS in Team Info section on MIDDLE SECTION.

INFORMATION

ACTION

D2 RESULTS OF COIN TOSS
Continued
LOST BOYS
 Receiving from **left** court;

WIZARDS
 Serving from **right** court;

SCORER

2. Record in **A/B** circles:
 - a. **A** next to **LOST BOYS**;
 (In **LEFT** and **RIGHT** sections)
 - b. **B** next to **WIZARDS**.
3. Record **X** through:
 - a. The **(R)** for **LOST BOYS**;
 - b. The **(S)** for **WIZARDS**;
4. Record **X** in **LOST BOYS Service Rounds**, column **I**, box **1**.

ASSISTANT SCORER
 Will Record Information On **LIBERO CONTROL SHEET**

For all non-deciding sets:
 In **LEFT** and **RIGHT** sections:

5. Record **A** in **AorB** circles.
6. Record **LOST BOYS** next to **Libero** boxes.

In the **MIDDLE** section:

7. Record **B** in **AorB** circle.
8. Record **WIZARDS** next to **Libero** boxes.

D3 ROSTERS

LOST BOYS: 9 Team Captain;

WIZARDS: No captain indicated;

SCORER

In **LEFT** and **RIGHT** sections:
 Above **LOST BOYS**

1. Record **9** in **CAPTAIN** box.

In **MIDDLE** section:
 Above **WIZARDS**

2. Record **X** in **CAPTAIN** box.

D4 LOST BOYS LINE-UP SHEET

SET 3		LIBERO
LINE-UP SHEET		Nº
TEAM	LOST BOYS	9c X
IV	III	II
47	17	8
V	VI	I
23	2	15
SERVICE		
COACH SIGNATURE		
<i>Lostboys Boss</i>		

SCORER

In **LEFT** and **RIGHT** sections:
Next to LOST BOYS

1. In **Libero#** boxes:
2. Record:
 - a. **9** in first box;
 - b. **X** in second box.

Below LOST BOYS

3. Record line-up in **SERVICE ORDER** section.

INFORMATION

ACTION

D4 LOST BOYS LINE-UP SHEET Continued

SET 3		LIBERO
LINE-UP SHEET		N°
TEAM	LOST BOYS	9c X
IV	III	II
47	17	8
V	VI	I
23	2	15
SERVICE		
COACH SIGNATURE		
<i>Lostboys Boss</i>		

SCORER
In LEFT and RIGHT sections: Above LOST BOYS 4. Record captain: a. 9 in CAPTAIN circle.
ASSISTANT SCORER
For LOST BOYS 5. Record Liberos: a. 9 in L box; b. X in R box. In the LEFT and RIGHT sections: 6. Record the starting line-up in the SP column.

D5 WIZARDS LINE-UP SHEET

SET 3		LIBERO
LINE-UP SHEET		N°
TEAM	WIZARDS	6 20
IV	III	II
4	1c	3
V	VI	I
5	7	9
SERVICE		
COACH SIGNATURE		
<i>Wizard Leader</i>		

SCORER
Next to WIZARDS 1. Record, in Libero# boxes: a. 6 in first box; b. 20 in second box. Below WIZARDS 2. Record line-up in the SERVICE ORDER section. Above WIZARDS 3. Record team captains: a. 1 in CAPTAIN circle:
ASSISTANT SCORER
In MIDDLE section: For WIZARDS 4. Record Liberos: a. 6 in L box; b. 20 in R box; 5. Record the starting line-up in the SP column.

AcrB (A) SP	Libero L R 9 X	LOST BOYS	AcrB (B) SP	Libero L R 6 20	WIZARDS	AcrB (A) SP	LOST BOYS
I	15		I	9		I	15
II	8		II	3		II	8
III	17		III	1		III	17
IV	47		IV	4		IV	47
V	23		V	5		V	23
VI	2		VI	7		VI	2

INFORMATION

ACTION

<p>D6 RECOMMENDED SUBSTITUTION PROCEDURE</p> <p>ROSTERS ARE NOT USED AT ALL EVENTS</p> <p>REQUIRED FOR NATIONAL SCORERS</p>	<p style="text-align: center;">SCORER</p> <p>After comparing the rosters and line-up sheets: The Legal Substitutes are: LOST BOYS: 10, 11 WIZARDS: 14, 22</p> <p>1. Use recorded Legal Substitutes to confirm the substitute (incoming) is legal. In LEFT and RIGHT sections: Below LOST BOYS</p> <p>2. Record 10 11. 10 was replaced in Set 1 using an exceptional substitution. a. Draw a circle around 10 to indicate that 10 cannot enter the court.</p> <p>In the MIDDLE section: Below WIZARDS</p> <p>3. Record 14 22.</p>						
<table border="1" style="width: 100%; border-collapse: collapse;"> <thead> <tr> <th style="width: 20%; text-align: left;">LEFT LOST BOYS</th> <th style="width: 60%; text-align: center;">MIDDLE WIZARDS</th> <th style="width: 20%; text-align: right;">RIGHT LOST BOYS</th> </tr> </thead> <tbody> <tr> <td style="text-align: center;">(10) 11</td> <td style="text-align: center;">Substitutions 1 2 3 4 5 6 7 8 9 10 11 12 14 22</td> <td style="text-align: center;">(10) 11</td> </tr> </tbody> </table>		LEFT LOST BOYS	MIDDLE WIZARDS	RIGHT LOST BOYS	(10) 11	Substitutions 1 2 3 4 5 6 7 8 9 10 11 12 14 22	(10) 11
LEFT LOST BOYS	MIDDLE WIZARDS	RIGHT LOST BOYS					
(10) 11	Substitutions 1 2 3 4 5 6 7 8 9 10 11 12 14 22	(10) 11					
<p>D7 CHECKING LINE-UPS</p> <p>While reviewing the LOST BOYS line-up sheet, 2nd referee notices that Libero 9 is the team captain and game captain. Then 2nd referee asks the coach for an alternate game captain (when the Libero is not on the court). The coach indicates that 2 will be alternate captain. The 2nd referee informs the scorer of the alternate captain.</p>	<p style="text-align: center;">SCORER</p> <p>In LEFT and RIGHT sections: Above LOST BOYS</p> <p>1. Record alternate captain: a. 2 in first slot next to CAPTAIN circle.</p>						
<p>D8 LIBERO REPLACEMENT</p> <p>After 2nd referee and scorer check LOST BOYS line-up, LOST BOYS Libero 9 replaces 23. After 2nd referee and scorer check WIZARDS line-up, WIZARDS Libero 20 replaces 9.</p>	<p style="text-align: center;">ASSISTANT SCORER</p> <p>In LEFT section only: In LOST BOYS PLAYER section:</p> <p>1. Record L next to 23; a. Do not slash through 23. In MIDDLE section: In WIZARDS PLAYER section:</p> <p>2. Record R next to 9; a. Do not slash through 9.</p>						

INFORMATION	ACTION
D15 LOST BOYS TIME OUT Continued	2. Show 2 nd referee number of time outs taken by each team. At end of time out: 3. Show READY signal
D16 SUBSTITUTION LOST BOYS substitute 11 for 2 .	SCORER
	For LOST BOYS In Legal Substitutes section: 4. Confirm substitute is legal; 5. Slash through 11 to indicate that 11 has entered the court. In LOST BOYS LEFT and RIGHT sections: In Score at Substitutions column VI , first row under 2 : 1. Record 11 in left box; 2. Record 4:4 (score) in right box; In Substitutions row: 3. Slash through 1 .
	ASSISTANT SCORER
In LEFT and RIGHT sections: In LOST BOYS PLAYER section: 4. Record 11 next to 2 . 5. Slash through 11 .	
D17 LIBERO REPLACEMENT WIZARDS Libero 6 replaces 20 .	ASSISTANT SCORER
In MIDDLE section: In WIZARDS PLAYER section: 1. Record L next to R . 2. Do not slash through L .	
D18 LOST BOYS SERVE LOST BOYS 17 contacts the ball and serves 3 points before serving out of bounds.	SCORER
In LEFT section only : In LOST BOYS Service Rounds column III , box 1 , under 17 : 1. Draw small checkmark (✓) through 1 in upper right corner. In LOST BOYS Points column: 2. Slash through 5-7 . 3. Record LOST BOYS Exit Score 7 .	

INFORMATION	ACTION
<p>D18 LOST BOYS SERVE Continued</p>	<p style="text-align: center;">SCORER</p> <p>In MIDDLE section: In WIZARDS Points column: 4. Slash through WIZARDS rally point 5.</p>
<p>D19 WIZARDS SERVE</p> <p>WIZARDS 1 contacts the ball and serves out of bounds.</p>	<p style="text-align: center;">SCORER</p> <p>In MIDDLE section: In WIZARDS Service Rounds column II, box 1, under 3: 1. Draw small checkmark (✓) through 1 in upper right corner. 2. Record WIZARDS Exit Score 5. In LEFT section only: 3. Slash through LOST BOYS rally point 8.</p>
<p>D20 COURT CHANGE</p> <p>Court change point 8 has been scored.</p> <p>Teams change courts.</p> <p>LOST BOYS 47 will be next server.</p>	<p style="text-align: center;">SCORER</p> <p>In the LOST BOYS RIGHT section: In the Points at Chg circle: 1. Record 8. 2. Do not slash 1-8 in POINTS COLUMN. In LOST BOYS Service Rounds, column III, under 17: 3. Record 7. 4. Do not draw small checkmark (✓) through 1 in upper right corner.</p> <p style="text-align: center;">ASSISTANT SCORER</p> <p>In LOST BOYS RIGHT PLAYERS section: 5. Record L next to 8; a. Do not slash through 8. 6. Notify 2nd referee that both teams have Liberos on court; a. Hold both hands over the table with palms facing table.</p>
<p>THE LEFT SECTION OF THE SCORE SHEET IS NO LONGER USED</p>	

INFORMATION	ACTION
<p>D21 LIBERO REPLACEMENT</p> <p>LOST BOYS 8 replaces Libero 9.</p> <p>Scorer notices that LOST BOYS captains (9 or 2) are not on the court.</p> <p>2nd referee confers with coach, who decides that 17 will be the alternate captain and informs scorer.</p>	<p>ASSISTANT SCORER</p> <p>In LOST BOYS PLAYER section:</p> <ol style="list-style-type: none"> 1. Record 8 next to L; a. Do not slash through L. <p>SCORER</p> <ol style="list-style-type: none"> 2. Notify 2nd referee that LOST BOYS need a captain. 3. Slash 2 in CAPTAIN slot. 4. Record 17 in the next slot.
<p>D22 LOST BOYS SERVE</p> <p>LOST BOYS 47 contacts the ball and scores 1 point.</p> <p>LOST BOYS lose the next rally.</p>	<p>SCORER</p> <p>In LOST BOYS Service Rounds column IV, box 1, under 47:</p> <ol style="list-style-type: none"> 1. Draw small checkmark (✓) through 1 in upper right corner. <p>In LOST BOYS Points column:</p> <ol style="list-style-type: none"> 2. Slash through 9. 3. Record LOST BOYS Exit Score 9. 4. Slash through WIZARDS rally point 6.
<p>D23 LIBERO REPLACEMENT</p> <p>WIZARDS 9 replaces Libero.</p>	<p>ASSISTANT SCORER</p> <p>In WIZARDS PLAYER section:</p> <ol style="list-style-type: none"> 1. Record 9 next to L; a. Do not slash through L.
<p>D24 SUBSTITUTION</p> <p>WIZARDS substitute 22 for 4.</p>	<p>SCORER</p> <p>For WIZARDS</p> <p>In Legal Substitutes section:</p> <ol style="list-style-type: none"> 1. Confirm substitute is legal; Slash through 22 to indicate that 22 has entered the court. <p>In Score at Substitutions column IV, first row under 4:</p> <ol style="list-style-type: none"> 2. Record 22 in left box; 3. Record 6:9 (score) in right box; <p>In Substitutions row:</p> <ol style="list-style-type: none"> 4. Slash through 1.

INFORMATION	ACTION
<p>D24 SUBSTITUTION Continued</p>	<p>ASSISTANT SCORER</p> <p>In WIZARDS PLAYER section:</p> <ol style="list-style-type: none"> 4. Slash through 22. 5. Record 22 next to 4;
<p>D25 WIZARDS SERVE</p> <p>WIZARDS 22 contacts the ball and serves 4 points before WIZARDS lose the serve.</p>	<p>SCORER</p> <p>In WIZARDS Service Rounds column IV, box 1, under 47:</p> <ol style="list-style-type: none"> 1. Draw small checkmark (✓) through 1 in upper right corner. <p>In WIZARDS Points column:</p> <ol style="list-style-type: none"> 2. Slash through 7-10. 3. Record WIZARDS Exit Score 10. 4. Slash through LOST BOYS rally point 10.
<p>D26 SUBSTITUTION</p> <p>LOST BOYS substitute 2 for 11.</p> <p>Note: 17 remains alternate captain even when 2 is on the court.</p>	<p>SCORER</p> <p>For LOST BOYS:</p> <p>In Score at Substitutions column VI, first row under 11:</p> <ol style="list-style-type: none"> 1. Record 2 in left box; 2. Record 10:10 (score) in right box; <p>In Substitutions row:</p> <ol style="list-style-type: none"> 3. Slash through 2. <p>ASSISTANT SCORER</p> <p>In LOST BOYS PLAYER section:</p> <ol style="list-style-type: none"> 4. Slash through 11. 5. Record 2 next to 11;
<p>D27 LOST BOYS SERVE</p> <p>LOST BOYS 23 contacts the serve.</p> <p>LOST BOYS loses the rally.</p>	<p>SCORER</p> <p>In LOST BOYS Service Rounds column V, box 1, under 23:</p> <ol style="list-style-type: none"> 1. Draw small checkmark (✓) through 1 in upper right corner. 2. Record LOST BOYS Exit Score 10. 3. Slash through WIZARDS rally point 11.

INFORMATION	ACTION
<p>D28 WIZARDS SERVE</p> <p>WIZARDS 5 contacts serve and scores 1 point.</p>	<p style="text-align: center;">SCORER</p> <p>In WIZARDS Service Rounds column V, box 1, under 5:</p> <ol style="list-style-type: none"> 1. Draw small checkmark (✓) through 1 in upper right corner. <p>In WIZARDS Points column:</p> <ol style="list-style-type: none"> 2. Slash through 12.
<p>D29 LOST BOYS TIME OUT</p> <p>LOST BOYS take second time out.</p>	<p style="text-align: center;">SCORER</p> <p>In second Time Out box under LOST BOYS Points column:</p> <ol style="list-style-type: none"> 1. Record 10:12 (score). 2. Show 2nd referee number of time outs taken by each team. <p>At end of time out:</p> <ol style="list-style-type: none"> 3. Show READY signal.
<p>D30 WIZARDS SERVE</p> <p>WIZARDS 5 serves into the net.</p>	<p style="text-align: center;">SCORER</p> <ol style="list-style-type: none"> 1. Record WIZARDS Exit Score 12. 2. Slash through LOST BOYS rally point 11.
<p>D31 LOST BOYS SERVE</p> <p>LOST BOYS 2 contacts serve and scores 2 points.</p>	<p style="text-align: center;">SCORER</p> <p>In LOST BOYS Service Rounds column VI, box 1, under 2:</p> <ol style="list-style-type: none"> 1. Draw small checkmark (✓) through 1 in upper right corner. <p>In LOST BOYS Points column:</p> <ol style="list-style-type: none"> 2. Slash through 12-13.
<p>D32 WIZARDS TIME OUT</p> <p>WIZARDS take first time out.</p>	<p style="text-align: center;">SCORER</p> <p>In first Time Out box under WIZARDS Points column:</p> <ol style="list-style-type: none"> 1. Record 12:13 (score). 2. Show 2nd referee number of time outs taken by each team. <p>At end of time out:</p> <ol style="list-style-type: none"> 3. Show READY signal.

INFORMATION		ACTION	
D33 LOST BOYS SERVE	LOST BOYS 2 contacts serve and scores 1 point before losing next rally.	SCORER	
		In LOST BOYS Service Rounds column VI , box 1 , under 2 : 1. Draw small checkmark (✓) through 1 in upper right corner. In LOST BOYS Points column: 2. Slash through 14 . 3. Record LOST BOYS Exit Score 14 . 4. Slash through WIZARDS rally point 13 .	
D34 WIZARDS SERVE	WIZARDS 7 serves the ball into the net to end the match.	SCORER	
		In WIZARDS Service Rounds column 1 , box 2 , under 7 : 1. Draw small checkmark (✓) through 1 in upper right corner. 2. Record WIZARDS Exit Score 13 . 3. Slash through LOST BOYS rally point 15 .	
USE BLUE/BLACK INK			
D35 SET END TIME	The set ends at 5:32 PM.	SCORER	
		In the End TIME box: 1. Record 17:32 .	
FOLLOW ALL POST SET PROCEDURES (E44-E48)			
D36 SPECIAL POST DECIDING SET PROCEDURES	Procedures E44-E48 are found in the previous section.	SCORER	
		1. Cancel unused points only in the MIDDLE and RIGHT Points columns.	

**SCORER
END OF MATCH PROCEDURES**

D37 MATCH RESULTS

On All Score Sheets Used For The Match

In the **MATCH WINNER** box on the upper right corner of the score sheet.

1. Record Winning team and **SETS** won and lost.

TEAM	MATCH WINNER	Sets	W	L
LOST BOYS			2	1

D38 SCORE SHEETS REVIEW

Check All Score Sheets For Completeness/Accuracy

1. **Set** numbers are printed or written for all sets.
2. **Start** and **End TIMES** are recorded.
3. Number of substitutions matches in all areas.
4. Last point recorded in **POINTS COLUMN**.
5. Last exit scores entered and circled.
6. Unused point are cancelled with **T-Bars**.
7. Correct winning and losing teams and scores are entered in all **RESULTS** boxes.
8. **MATCH WINNER** box completed.

D39 SIGNATURES

1. Scorer has signed all score sheets.
2. 1st referee has signed all score sheets.

D40 PROCESSING COMPLETED SCORE SHEET

1. Process completed score sheets as directed by tournament management.

FINISHED

AorB (A) SP Libero L 9 R X LOST BOYS	AorB (B) SP Libero L 6 R 20 WIZARDS	AorB (A) SP LOST BOYS
I 15	△ 9 R L 9	I 15
△ 8 L	II 3	△ 8 L 8
III 17	III 1	III 17
IV 47	IV ↗ 22	IV 47
V 23 L 23	V 5	V 23
VI ↗ 11	VI 7	VI ↗ 2

BASIC PROCEDURES FOR CONDUCTING A USA VOLLEYBALL MATCH/COMPETITION FOR REFEREES

These are the basic procedures to be followed when conducting official USA Volleyball matches or competitions. More detailed information for each of these items can be found in the “USAV Referee Guidelines and Instructions.”

1. OFFICIALS

- a. The officials should be certified USA Volleyball referees and qualified USA Volleyball scorers.
- b. The prescribed USA Volleyball uniform and certification patch should be worn by all referees.
- c. At a minimum, referee equipment includes a whistle with lanyard, a set of yellow/red cards, a flipping coin and a watch or timing device.

2. ARRIVAL

- a. Referees should arrive at the playing venue no fewer than 30 minutes prior to the start of the competition.
- b. The tournament director or event manager should be located at that time, and playing formats, ground rules, warm-up procedures and other protocols should be determined.

3. MATCH PREPARATION

- a. Referees or scorers should examine the court and playing equipment prior to the first match: identify court lines, playing area, and any floor obstructions; determine rulings for overhead obstructions; examine the playing equipment (including net, antennas, posts, referee stand and game balls); and verify the net height and ball pressure.
- b. Referees or scorers should ensure pens, pencils, score sheets and Libero control sheets are available at the score table. Line-up sheets and rosters may also be required.

4. REFEREE'S PRE-MATCH DUTIES

- a. Prior to the coin toss, the 1st and 2nd referees must discuss their match responsibilities, as well as communication techniques that will be used between them during the match. This should include: discreet help from the 2nd referee; addressing conduct issues; and ensuring consistent application of ground rules.
- b. Preferably prior to the coin toss, or immediately thereafter, the referees will meet with the officiating crew to give instructions to the line judges (1st referee) and scoring crew (1st or 2nd referee).

- c. Conduct a coin toss between the team captains prior to the start of the timed warm-up period. Once tossed, the coin should be caught and the result immediately revealed.
- d. After the coin toss, the 1st referee will supervise warm-up periods and may request the 2nd referee to time their duration. Note: In the event a team does not choose to use its time on the court, the court shall remain unoccupied.
- e. During the warm-up period, the 1st referee must verify the legality of each team's player and Libero uniforms. All players must wear uniforms as prescribed in Rule 4.3 and USAV Rule 4.3 and/or Rule 19.2 and USAV Rule 19.2.
- f. At the end of the warm-up period, the 1st or 2nd referee will blow a whistle to indicate that the warm-up period is over and players are to clear the court.
- g. Referees and other officials take their assigned places.

5. START OF THE FIRST SET OF THE MATCH

- a. Teams line up on the end line of their respective team courts. When both teams are ready, the 1st referee will blow a whistle and motion for players to take their positions on their court.
- b. The 2nd referee, using each team's submitted line-up sheet, and the scorer, using the score sheet, will verify that players are in the correct positions on the court. No corrections may be made unless an error or omission has been made by the scorer. Prior to the start of play, changes and/or substitutions can only be made under the provisions of Rules 4.1.3, 7.3.2 and 7.3.4. No other changes may be made in the line-ups to correct an error made by teams in preparing the line-up sheets. NOTE: A substitution prior to the start of any set is permitted.
- c. Upon completing the line-up check, the 2nd referee will permit Libero replacements to occur and confirm that the assistant scorer has recorded them.
- d. The 2nd referee then retrieves the game ball from the score table and delivers it to the first server of the match. The 2nd referee will then take a position on the receiving team's side of the net and indicate "ready" to the 1st referee. The 1st referee whistles and beckons for the first service of the set. This marks the time the set officially begins.
- e. Prior to the contact of the serve, serving team players should be in their correct positions on the court, with no distracting movements. Continual or distracting movement may be construed as screening. The 1st referee must be aware of screening during all service actions.

6. DURING THE MATCH

- a. Each referee has specific duties and responsibilities during the match as outlined in Rules 23 and 24.
- b. Judgment and ball handling decisions, as well as match control, flow and tempo, are very important for any 1st referee.
- c. Match administration (substitutions, time-outs, etc.), communication with the team benches and score table, and positioning/focus during net play are important aspects of working as a 2nd referee.
- d. Scorer, assistant scorer and line judge duties are clarified in Rules 25, 26 and 27, respectively.

7. PROCEDURES FOR REGULAR GAME INTERRUPTIONS

- a. Substitutes should enter the substitution zone and wait for the authorization to enter given by the 2nd referee. Entry into the substitution zone is the only legal way to request a substitution, except for injury situations or substitutions prior to the start of a set.
For multiple substitutions by the same team during one dead ball period, each player and his/her substitute must enter the substitution zone in succession, one pair at a time, and must wait until entry is authorized by the 2nd referee. For multiple substitutions by the same team, there can be no delay between incoming substitutes. When opponents request substitutions simultaneously, the 2nd referee must ask that one team wait while the other team's substitution is administered and recorded. After this substitution has been recorded, the 2nd referee will whistle to recognize the substitution for the other team and then authorize the substitute to enter the game.
- b. When the coach or playing captain requests a time-out, the 2nd (or 1st) referee should immediately whistle, show Signal 4, Time-out, and then indicate the team by pointing, open-handed, toward that team's bench. The 2nd referee will then visually inform the 1st referee of the number of time-outs each team has taken. After 30 seconds have elapsed, the 2nd (or 1st) referee must whistle to end the time-out. Teams should immediately retake the court. The 2nd referee will then verbally and visually notify each team's coach only when that team's second time-out has been taken. The 1st referee prepares for the next rally.

8. END OF THE SET AND START OF THE NEXT SET

- a. A set officially ends when the whistle is blown for the fault resulting in the winning point. The set interval begins when the 1st referee executes Signal 9, End of Set. Following the whistle indicating the end of a set, the referee will direct the teams to change playing areas and benches immediately, with the exception of the interval before the deciding set. In all but the deciding set, the players proceed to their right until they reach their new bench

- area with the team on the left passing behind, or if court space is limited, directly in front of, the 1st referee and proceeding to the bench.
- b. The 2nd referee will collect the line-ups from both teams as quickly as possible during the set interval; however, line-ups must be submitted within two minutes and 30 seconds during the set interval. With 30 seconds remaining in the interval, the 2nd referee will blow a whistle and teams shall immediately report to the court and line up in their proper positions to start the set.
 - c. When a deciding set will be necessary, the teams follow a different procedure at the end of the set prior to the deciding set. Following the whistle indicating the end of the set, the 1st referee will release the teams to their respective benches. The game captains for each team then immediately meet at the scorer's table, where the 1st (or 2nd) referee will conduct the coin toss for the deciding set. Once the choice of sides has been determined, the 1st referee whistles and directs the teams to their appropriate team areas, using the procedure specified in 8a above if a change of court is necessary. The procedure for the start of the deciding set is the same as stated in 8b.

9. CHANGE OF TEAM AREAS DURING A DECIDING SET

- a. When teams change team areas during a deciding set of a match (Rule 18.2 & USAV 6.3b), the 1st referee will blow a whistle and show Signal 3, Change of Courts. Teams will change playing areas as noted in 8a above, without delay and with player positions remaining the same.
- b. Substitutes and other team personnel will change team areas in front of the score table.
- c. If requested, the 2nd referee will verify that players are in their correct positions on the court.

10. AT THE END OF THE MATCH

- a. Following the whistle indicating the last rally of a match, the 1st referee will whistle again and display Signal 9, End of Match, and direct the players of each team to line up on the end line of their team court.
- b. When both teams are in position, the 1st referee will blow a final whistle and motion for the teams to proceed to the center of the court to shake hands with the opponents.
- c. The 2nd referee will ensure that the game ball is returned to the designated area for safekeeping.
- d. Both team captains shall thank the referees.
- e. The 1st referee will then review the score sheet to verify the final results and ensure the scorer has signed the sheet. The 1st referee will then sign the score sheet(s).
- f. Referees will then immediately depart the playing area.

USA Volleyball Match Protocol for Use at the USA Volleyball Open National Championships

Countdown to First Serve

Activity in Control Area

10:00

REFEREES: Check net height.

9:30

TEAMS: Stretch/pepper on own courts.

REFEREES/CAPTAINS/HEAD COACHES: Coin toss; captains sign score sheet, followed by head coach's signature; second referee delivers line-up sheets.

8:30

TEAMS: Continue to stretch/pepper on own courts.

REFEREES: First referee whistle starts 6 minutes (or 3/3) warm-up; instruct line judges and scorers; check equipment.

6:00

TEAMS: Teams warm up on (off) court.

REFEREES: Second referee collects line-ups from coaches, submits to scorer.

(5:30)

(1st REFEREE ends/starts 1st/2nd warm-up.)

2:30

REFEREES: First referee whistles end of warm-up.

TEAMS: Go to benches/prepare for presentation of match.

2:00

REFEREES: Line-up on sideline in front zone near scorer's table.

TEAMS: Line up on sideline in back zone (captain first).

RFS/TMS: 1st leads all to center/whistles to shake hands/then teams return to benches for final talk.

1:00

REFEREES: Presentation/shake hands, then to positions.

TEAMS: All at benches/prepare for start.

:30

REFEREES: 2nd checks line-ups/gives ball to first server.

TEAMS: Starters line up on court/Libero awaiting 2nd's approval/substitutes seated at bench or in warm-up area.

:00

REFEREES: 1st whistles for first service.

USA Volleyball Junior Match Protocol

AM Wave Countdown	ACTIVITY in the CONTROL AREA	Match Protocol Sequence After First Match
07:44:00 AM	REFEREES: Check net height TEAMS: Stretch/Pepper on own courts.	Start of 2 Minutes Shared Court
07:44:30 AM	REFEREES/CAPTAINS: Coin Toss Head Coaches receive line-up forms from 2nd Referee. TEAMS: Continue to Stretch/Pepper on own courts.	
07:46:00 AM	REFEREES: 2nd Referee whistles start of 4-minute warm-up for serving team. 1st Referee instructs line judges; 2nd Referee instructs Scorers; both referees inspect equipment. TEAMS: Serving team has entire court; receiving team warms up off court.	Start of 1st 4-minute warm- up
07:50:00 AM	REFEREES: 2nd Referee whistles end of 4-minute warm-up for serving team and start of warm-up for receiving team. TEAMS: Receiving team has entire court; serving team warms up off court.	Start of 2nd 4-minute warm- up
07:52:00 AM	REFEREES: 2nd Referee collects line-ups from coaches for the scorer.	Two minutes remaining in warm-up
07:54:00 AM	REFEREES: 2nd Referee whistles end of warm-up period. TEAMS: Go to benches for final talk.	End of 4-minute warm-ups Conclusion of warm-ups
07:55:00 AM	REFEREES: Line up on bench sideline in front zone. TEAMS: Line up on bench sideline in back zone (captain first, starting Libero second).	Immediately
07:59:00 AM	REFEREES/TEAMS: 1st referee leads all to center and whistles for teams to shake hands, after which the substitutes immediately return to their benches, the starters go to their court positions, and the referees shake hands and go to their positions.	As soon as all are in-line
07:59:30 AM	TEAMS: Starting Libero awaits 2nd referee's approval to enter the court; substitutes are in the warm-up area (if they are standing) or are seated on the bench. REFEREES: 2nd referee checks line-ups and gives the game ball to the first server.	Prior to the start of the match
08:00:00 AM	REFEREES: 1st referee whistles for first service.	Match begins

GUIDELINES FOR CONDUCTING INDOOR TOURNAMENTS/LEAGUES

To assure maximum efficiency and consistency throughout USA Volleyball in the conduct of sanctioned competition, as well as fair and equitable treatment of teams and players, principles and guidelines have been established by USA Volleyball. These should be considered as the national minimum standard and should be an integral part of the sanction agreement with USA Volleyball and/or the Regional Volleyball Association.

It is recognized that not all organizations and facilities have the minimum resources available to meet these minimum standards continually. In these cases, reasonable alternatives should be provided.

The rules offer many options to allow for a wide range of use. It is the responsibility of the Tournament or League Director to specify in writing which options or modifications to the rules will be enforced. Players must be notified of all Tournament/League Regulations prior to the start of play and preferably before the acceptance of any entries.

Guidelines for specific nationally-sanctioned tournaments can be found on the web site at www.usavolleyball.org.

A. GENERAL INFORMATION

1. All tournament regulations must be within the guidelines of the governing organization.
2. Common sense may dictate that adaptations to the rules may enhance the playing experience in certain situations.
3. All adaptations to the rules and tournament guidelines must be for the improvement of the game for the participants involved. Principles of fairness and increased participation should guide decisions to adapt playing rules.
4. When in doubt, contact the volleyball authority within your organization.

B. APPLICATION/PREPARATION

1. Tournament Directors should apply for and receive sanction from their respective state, regional or national authority. Requests for any waivers to the rules should be submitted to the appropriate authority at this time or as soon as the need has been determined.
2. Obtain the correct forms and equipment to have available at the site such as:
 - a. Appropriate equipment (nets, standards, antennae, volleyball, etc.) to conduct competition consistent with the rules.

- b. A copy of the current Domestic Competition Regulations and any specific tournament/league guidelines.
 - c. USA Volleyball score sheets, line-up sheets and Libero control sheets. These may be printed from the web site at www.volleyballreftraining.net/resources_scoring_materials.php or purchased through the on-line store at www.em2sports.com/officiating-amp-coaching-tools.html.
3. For large, multi-court tournaments, the following is recommended:
 - a. A non-playing tournament director/manager with the sole responsibility of keeping the tournament on schedule and properly recorded; OR
 - b. A court manager for every 1-4 courts, all of whom are collectively charged with the above responsibilities; AND
 - c. A non-playing certified referee in charge who shall be designated to handle all referee assignments.
 - d. The duties of the Head Referee may include identifying a protest committee and working with the tournament director to identify ground rules. He/she may also be charged with setting a referee schedule when certified match officials are used.
 4. For smaller tournaments and leagues, some of these duties may be combined.
 - a. A one-court facility may require only one person to act as the site director and the head referee.
 - b. A two- to four-court facility with a paid referee on each court might require only one tournament/league director, who may also act as head referee.

C. FEES/AWARDS

1. Each tournament situation is unique. The entry fee should be commensurate with expenses incurred. Some considerations should be:
 - a. paid officials,
 - b. cost of facilities, equipment and administrative supplies/costs,
 - c. awards,
 - d. sale of food items, merchandise, etc., to help defray expenses,
 - e. contribution to USA Volleyball Foundation, Endowment Fund or other charity,
 - f. payment of expenses to team(s).
2. Selection of awards is generally dependent upon the

number of teams entered, the age of the participants and the financial resources available. Awards may include:

- a. team trophies or plaques,
- b. individual awards such as medals, plaques, t-shirts or other merchandise,
- c. money back in the form of expenses or future tournament entry fees.

D. TYPES OF TOURNAMENTS

1. Double Elimination: Because of the obviously limited play potential for the weaker teams, this type of tournament is discouraged.
2. Round Robin: This is more universally accepted because all teams are guaranteed a reasonable number of sets/matches. It also is more practical for the assignment of support officials. A multi-court round robin in the same division/class will require a championship playoff. A single-court round robin does not require a playoff. Such an arrangement is discouraged.
3. Many large national-level and festival-type tournaments have more than one round of pool play (round robin) culminating in a single- or double-elimination round.

E. SCHEDULING PARAMETERS

1. Scheduling matches for a tournament must be realistic. These time allowances provide for a six-minute warm-up between matches and three minutes between sets. Usually, only the results of full matches (two out of three or three out of five 25 rally point sets with the deciding set to 15 rally points) are acceptable for seeding purposes for national-level events. Playing formats may be adjusted to fit the needs of the tournament. For example, if a team drops out at the last moment, three sets to 25 points might be played to ensure that a minimum number of sets are played by the remaining teams.

Two 25 rally point sets	50 minutes
Two 21 rally point sets	45 minutes
2/3 25 rally point sets per match (15-pt. third set)	1 hr. 5 min.
2/3 21 rally point sets per match (15-pt. third set)	1 hour (JNC format)
One 15 rally point set	20 minutes
One 25 rally point set	26 minutes
3/5 25 rally point set per match (15-pt. fifth set)	1 hr. 45 min.

2. At least five additional minutes of warm-up shall be allotted for the first match for each team except in those facilities that provide an adequate warm-up area not in conflict with the playing areas.
3. Teams should play at the announced time when their match is sequentially ready to be played, regardless of the time schedule. The time schedule is only a guideline. EXCEPTION: The first match of the day for each team should be governed by the announced/scheduled starting time only. Some large tournaments (national level) may have their own written guidelines for their tournament schedules. For example, it is standard at large junior tournaments for pool play matches to start at the scheduled time with the provision that a match may start no more than 10 minutes early, provided both playing teams and the referees agree.
4. The tournament schedule and forfeit procedures should be clearly posted and all teams informed.
5. Samples of various round robin schedules (officialiating team in parentheses):

Pool play sequences, listed below, are allowable for use with all respective pools in an NQ, unless another sequence is approved by the Events Department.

Round	Four-Team Pools	Three-Team Pools	Five-Team Pools on 2 courts *
Match 1	1 vs. 3 (ref 2)	1 vs. 3 (ref 2)	1 vs. 5 and 2 vs. 4 (ref 3)
Match 2	2 vs. 4 (ref 1)	2 vs. 3 (ref 1)	1 vs. 4 and 2 vs. 3 (ref 5)
Match 3	1 vs. 4 (ref 3)	1 vs. 2 (ref 3)	½ Hour Break
Match 4	2 vs. 3 (ref 1)		1 vs. 3 and 4 vs. 5 (ref 2)
Match 5	3 vs. 4 (ref 2)		2 vs. 5 and 3 vs. 4 (ref 1)
Match 6	1 vs. 2 (ref 4)		½ Hour Break
			1 vs. 2 and 3 vs. 5 (ref 4)

Round	Four-Team Pools court 1 *	Four-Team Pools court 2 *
Match 1	A 1 vs. 3 (ref B3)	A 2 vs. 4 (ref B2)
Match 2	B 1 vs. 3 (ref A3)	B 2 vs. 4 (ref A4)
Match 3	A 2 vs. 3 (ref B3)	A 1 vs. 4 (ref B4)
Match 4	B 2 vs. 3 (ref A2)	B 1 vs. 4 (ref A4)
Match 5	A 1 vs. 2 (ref B4)	A 3 vs. 4 (ref B1)
Match 6	B 3 vs. 4 (ref A1)	B 1 vs. 2 (ref A3)

JNC FORMAT

Round	Four-Team Pools	Three-Team Pools	Five-Team Pools on 2 Courts
Match 1	1 v 3 (ref 2)	1 v 3 (ref 2)	1 v 5 and 2 v 4 (ref 3)
Match 2	2 v 4 (ref 1)	2 v 3 (ref 1)	1 v 4 and 2 v 3 (ref 5)
Match 3	1 v 4 (ref 3)	1 v 2 (ref 3)	1/2 Hour Break
Match 4	2 v 3 (ref 1)		1 v 3 and 4 v 5 (ref 2)
Match 5	3 v 4 (ref 2)		2 v 5 and 3 v 4 (ref 1)
Match 6	1 v 2 (ref 4)		1/2 Hour Break
Match 7			1 v 2 and 3 v 5 (ref 4)

F. METHOD OF PLAY

(ONE-DAY TOURNAMENTS)

1. When round robin competition is scheduled, a maximum of five teams only should be accepted per available court.
2. When round robin play qualifies teams for a championship playoff, no more than 50 percent of the teams entered should advance to the championship playoff bracket.
3. The championship bracket is recommended not to exceed eight teams.
4. When two four-team brackets are scheduled, a championship and consolation pool may be formed from a first-round robin competition. Subsequent competition utilizing the top two and bottom two teams will determine first, second, third from the championship pool and fourth place by winning the consolation pool.
5. In round robin play the following will prevail:
 - a. If five teams are entered and a championship playoff is scheduled, matches may consist of either two 21 rally point sets or two 25 rally point sets. Time might not allow the use of either the best of three or three-set matches.
 - b. If five teams are entered and a championship playoff is not scheduled, matches may consist of either two 21 rally point sets or two 25 rally point sets. Time may not allow the use of the best of three or three-set matches.
 - c. If four teams are entered, matches may consist of any format, as long as it meets a reasonable time frame and is fair to all team entries proportionate to their entry fee and travel time. Some options include four-team pool play three sets to 25 rally points or best two-out-of-three 25 rally point sets (15 rally point third set).
 - d. Where there is only one pool, and a total round robin is scheduled, additional matches are not recommended. If a championship playoff is scheduled, the following criteria should be met:
 - (1) Projected time schedule will permit such additional scheduling.
 - (2) Playoffs should be restricted to the first- and second-place teams only.
 - (3) The second-place team should win at least 75 percent of its sets in round robin competition.
6. Finals should be scheduled to begin no later than 9 p.m. and earlier if possible.

G. WARM-UP PROCEDURES

Adult Competition:

1. Usually, because of limited time, the teams preparing to play the next match must be ready to take the court immediately at the end of the previous match. Warm-up time for the teams will probably vary from 5 to 10 minutes, depending on the tournament guidelines.
2. After the coin toss, one of the following warm-up procedures is specified:
 - a. The warm-up time is split evenly in two, with the serving team taking the court for the first half and the receiving team taking the court for the second half. The teams may use the entire court in whatever manner they choose during their time, including serving practice.
 - b. Shared hitting - both teams using the court to practice hitting at the net. The court should be split down the middle, perpendicular to the net so that the teams are hitting from their left side and down the line. Each team may practice blocking its own players. For the safety of the players, the referees should monitor that teams are not hitting into each other. If the teams are unable or unwilling to control their hitting, the referee would have the teams revert to option a or c.
 - c. A variation of “a” and “b” is to allow both teams to serve together for the last minute or two of the warm-up period. For example, if the total warm-up time is five minutes, the teams would share the court for four minutes and serve together for one minute (option a) or each would use the court for two minutes separately and then serve together for one minute (option b).
 - d. Pre-match Protocol for Adult Open Divisions can be found on page 199.

Junior Competition:

1. For National Junior Volleyball events, the 2-4-4 format is used and should be used at all events. The first two minutes are for ball handling on a team’s own side of the court, followed by four minutes of the entire court use by the serving team and then 4 minutes for the receiving team. Serving is conducted during each team’s four minutes. Shared hitting/serving is prohibited at Junior events. Pre-match Protocol for the Junior National Championships can be found on page 200.

H. GENERAL GUIDELINES FOR THE DETERMINATION OF PLAYOFF POSITION(S) IF TIED -- METHOD ONE

1. Teams qualifying for the playoffs, but tied for position only, should not compete in a playoff set to determine position; rather, position assignment should be determined by the priority system listed below based on point differential to the extent possible.
 - a. Results of the match(es) between the tied teams, first on the won-lost record, and second on the point spread. If still tied, then;
 - b. comparison of the point differential based on the total round robin competition. Point differential should be determined by subtracting the total points lost from the total points won. The highest plus or the lowest minus remainder should be considered the superior team for tie-breaking purposes. If still tied, then;
 - c. coin toss.
2. If there are more teams tied for the playoffs than there are positions, the tied teams must compete for the position(s) in further direct competition. Teams should NOT be eliminated from assignment to championship competition by point differential or any other non-competition system.
3. If two or more teams are tied for a single playoff position, the minimum number of one additional 25 rally point set should be played. Teams should change sides at 13 points. No cap shall be in effect. Where tournament guidelines stipulate, 15-point sets may be used. For example:
 - a. Two teams tie for last position: One 25 rally point set.
 - b. Three teams tie for last position: Superior as determined by the criteria in G1 shall be the bye team and play the winner of the match between the two remaining teams. Two 25 rally point sets total.
 - c. Four teams tie for last position: As determined by the criteria in G1, team 1 vs. 4, 2 vs. 3 and winners play off. Three 25 rally point sets total.
4. If three teams tie for two playoff positions, the team with the greater point spread shall be awarded first place. The other two teams shall play one 25 rally point set for the remaining playoff position. The same priorities as listed in G1 shall prevail, except that if a tie shall exist after the second priority, the flip of a coin shall determine the bye team, and all teams must play for position as follows:
 - a. Team Blue wins over Team White and gains one

- playoff berth.
- b. Team Red plays the loser, in this case Team White, for the second playoff berth. Two 25 rally point sets total.
5. These are only guidelines. Other methods are acceptable, as long as they are printed and distributed before the start of the event.

I. TIE BREAKER PROCEDURES FOR NATIONAL-LEVEL JUNIOR COMPETITION

Check the USAV website for the most updated procedure for specific events including National Qualifiers, National Bid Tournaments and National Championship Events. At the conclusion of a pool, teams in the pool will be ranked according to their match records. If a tie-in-match record exists between two or more teams, tie(s) will be broken using these USA Junior National Tie Break Formats for competition in which there is an opportunity to win a bid. The following policies apply to all tie-breaking situations:

- Divisions playing 3-out-of-5 sets and pools of six teams or more: If there are more teams tied by match record for advancing positions into the Gold Level than there are available positions, advancement will be decided by the win/loss ratio for the total number of sets played in the pool. If a tie still exists, the remaining tie-breaking procedures will be followed.

- All tie-breaking sets will be played to 25 points, with one team winning by two points and no point cap.

- In a tie breaker situation of three teams or more, if more than one team leaves the site, the remaining teams will play for position. The team(s) that left will be placed lower than the team(s) that remained. The position of all teams that left the site will be decided following the tie breaker procedure for non-gold division divisions (set percentage, point w/l, and coin flip).

Two-way Ties (two teams tied in match record)

The first place team will be the team that won the pool play match between the two tied teams (head-to-head).

This procedure will be used for all two-way ties, even when there is an opportunity to win a bid. The rationale is that the tied teams have already determined the better team through head-to-head competition.

Three-way Ties (three teams tied in match record)

There are several situations in which three-ways ties can occur. The resolution for each tie-breaking situation depends on:

- The number of teams that will advance from the pool.
- Which pool placement finish is at stake for the tied teams.
- For tie breaking purposes, all ties will be broken using match %

as the first criteria, including those cases where a third set is played regardless of the outcome of the first two sets.

Scenario One

No. Teams Advancing	Pool Finish	Applications
1	First place	4-team pools: All teams have 2-1 match records 3-team pools: All teams have 1-1 match records

- All three teams will participate in tie-breaking sets. The seeds for the tie-breaking playoffs will be determined in this order:

1. Win/loss ratio of the total number of sets played in the pool: Sets won divided by total sets played.
2. Point percentage: Each team’s total points scored divided by the total points scored by the team’s opponents in that pool.
3. Coin toss.

- Set 1: the #2 seed will play the #3 seed and the #1 seed will officiate. The loser of Set 1 will be third place in the pool and will officiate the next tie-breaking set.

- Set 2: the winner of Set 1 will play the #1 seed and the loser of Set 1 will officiate. The winner of Set 2 will be first in the pool and the loser will be second.

If one of the teams in a three-way tied pool leaves the site before the determination that a tie-break is necessary, that team will automatically become the third-place team and the other two teams will play one tie-breaking set.

Scenario Two

No. Teams Advancing	Pool Finish	Applications
2	First place	4-team pools: All teams have 2-1 match records 3-team pools: All teams have 1-1 match records

- The seeds for the tie-breaking playoffs will be determined in this order:

1. Win/loss ratio of the total number of sets played in the pool: Sets won divided by total sets played.
2. Point percentage: Each team’s total points scored divided by the total points scored by the team’s opponents in that pool.
3. Coin toss.

- The #1 seed does not have a playoff set. The #1 seed finishes

first in the pool.

•The #2 seed will play the #3 seed and the #1 seed will officiate. The winner will be second place in the pool and the loser of this set will be third place in the pool.

If one of the teams in a three-way tied pool leaves the site that team will be ranked third in the pool. The remaining two teams will finish first and second in the pool based on the tie-break seeding process. No other penalty will be applied and no tie-breaking set is played.

Scenario Three

No. Teams Advancing	Pool Finish	Applications
2	Second place	4-team pools: All teams have 1-2 match records

•All three teams will participate in tie-breaking sets. The seeds for the tie-breaking playoffs will be determined in this order:

1. Win/loss ratio of the total number of sets played in the pool: Sets won divided by total sets played.
2. Point percentage: Each team's total points scored divided by the total points scored by the team's opponents in that pool.
3. Coin toss.

•Set 1: the #2 seed will play the #3 seed and the #1 seed will officiate. The loser of Set 1 will be fourth place in the pool and will officiate the next tie-breaking set.

•Set 2: the winner of Set 1 will play the #1 seed and the loser of Set 1 will officiate. The winner of Set 2 will be first in the pool and the loser will be third.

If one of the teams in a three-way tied pool leaves the site before the determination of a tie-break is necessary, that team will automatically become the fourth-place team and the other two teams will play one tie-breaking set.

Scenario Four

No. Teams Advancing	Pool Finish	Applications
3	Second place	4-team pools: All teams have 1-2 match records

•The seeds for the tie-breaking playoffs will be determined in this order:

1. Win/loss ratio of the total number of sets played in the pool: Sets won divided by total sets played.
2. Point percentage: Each team's total points scored divided by the total points scored by the team's opponents in that pool.

3. Coin toss.

•The #1 seed does not have a playoff set. The #1 seed finishes second in the pool.

•The #2 seed will play the #3 seed and the #1 seed will officiate. The winner will be third place in the pool and the loser of this set will be fourth place in the pool.

If one of the teams in a three-way tied pool leaves the site and does not fulfill the officiating assignment, that team will be ranked fourth in the pool. The remaining two teams will finish second and third in the pool based on the tie-break seeding process. No other penalty will be applied and no tie-breaking set is played.

Non-elimination Scenarios

If no team is eliminated from an opportunity to win a bid, there will be no tie-breaking sets. In three-way ties, ties will be broken, without repetition, in this order:

1. Pool match record.
2. Head-to-head results.
3. Set percentage: Sets won divided by total sets played.
4. Point percentage: Each team's total points scored divided by the total points scored by the team's opponents in that pool.
5. Coin toss.

J. DUTIES OF COURT MANAGERS

1. The court manager is responsible for getting matches and officials on and off the court.
2. The officials for each match at major tournaments include a 1st referee, 2nd referee, scorer, assistant scorer, timekeeper/visual scoreboard operator and two line judges.
3. The court manager needs to check equipment (nets, standards, volleyballs, antennas, etc.) to make certain they are in good condition at all times.

K. PROCUREMENT/ASSIGNMENT OF REFEREES

1. All referees assigned to sanctioned USA Volleyball or Regional competition should be duly certified USA Volleyball referees unless otherwise approved by the Regional Referees Chair.
2. Non-player certified referees, as well as available certified player referees, may be used in all sanctioned competition.
3. All non-player USAV certified referees are required to wear the approved volleyball officials' uniform.
4. All match assignments shall be made by the designated Head Referee. In the absence of a Head Referee, the Tournament Director will act in this capacity.

5. Other organizations that sponsor volleyball activities may want to contact the USA Volleyball Regional Commissioner or Referees Chair to obtain clinic and certification information and gain access to the USA Volleyball certified officials in the area.

L. ASSIGNMENT OF SUPPORT OFFICIALS

1. The primary responsibility for the assignment of support officials should lie with the Tournament Director.
2. Participating teams may be expected to furnish required support officials as requested. Required officials are the second referee, the scorer, the assistant scorer, two line judges and visual score board operator. It is recommended that only USA Volleyball certified scorers should serve in the capacity of scorer.
3. A working schedule, including playoff sets, should be posted prior to the first match of the day so teams will be properly informed as to respective responsibilities. In addition, teams assigned to work the first scheduled matches should be notified at least three days in advance of the tournament. Those work teams failing to meet this obligation may be subject to discipline within their organization.
4. As part of item "3" above, teams playing in the final round robin match of the day, if not otherwise a participating team, will be assigned to the first level of the playoff matches. Losers of the play-off matches will be required to work the next level of the playoffs. Teams not fulfilling these assignments may be subject to discipline within their organization.
5. Any penalties for teams that do not fulfill their officiating responsibilities should be posted prior to play. One commonly used method is to penalize the assigned officiating team one point per minute up to a maximum of 25 points (one set), which would be imposed at the beginning of the team's next match. The penalty points would begin at the start of the second team's warm-up period.

GUIDELINES FOR DEALING WITH BLOOD

If a player incurs an injury that causes bleeding, the first or second referee shall immediately stop the set in accordance with Rule 17.1.1. The player shall leave the court for evaluation/treatment. If the player cannot continue play and must be replaced, this should be done within the guidelines of Rule 15.6 or 15.7. If substitution cannot be made, refer to Rule 17.1.2. If a player's uniform becomes saturated with blood, a change of uniform will be authorized. This change should be accomplished as quickly as possible to cause no additional delay of set. The replacement uniform should be of a similar color and style. Though duplicate numbers will not be allowed, no sanction will be assessed if the player's uniform number is different than the original number. If a replacement uniform is not available, the player must be replaced by a legal substitution. If the referee observes blood on the playing surface or equipment, the set shall be stopped immediately and measures taken to clean any contaminated area or equipment using universal precautions.

ABBREVIATIONS

m	=	meter
'	=	foot (feet)
cm	=	centimeter
"	=	inches
gm	=	grams
mbar	=	millibars
kg/cm ²	=	kilograms per square centimeter
lbs/sq in	=	pounds per square inch
		lbs/sq in = 68.0 mbar = 0.0703 kg/cm ²
°C	=	degrees Celsius
°F	=	degrees Fahrenheit

METRIC CONVERSIONS

Length of playing court	18 m	=	59'
Width of playing court	9 m	=	29'6"
Diagonal of half the playing court	12.728 m	=	41'8 1/2"
Minimum length of net	9.5 m	=	32'
Minimum width of free zone	3 m	=	9'10"
Recommended height of posts	2.55 m	=	8'4"
Height of men's net	2.43 m	=	7'11 5/8"
Height of women's net	2.24 m	=	7'4 1/8"
Height of 12 & under net	2.13 m	=	7'
Height of 10 & under net	1.98 m	=	6'6"
Length of antenna	1.8 m	=	5'11"
Net width:			
Max. side line – post distance	1 m	=	39"
Length of antenna above net	0.8 m	=	32"
Circumference of ball	65-67 cm	=	25 1/2-27"
Referee's view above net	50 cm	=	19 1/2"
Sand depth:			
Min. side line – post distance	30 cm	=	12"
Size of net mesh squares	10 cm	=	4"
Max. width of side line band	8 cm	=	3 1/8"
Min. width of side line band	5 cm	=	2"
Max. width of side line rope	1 cm	=	3/8"
Min. width of side line rope	0.5 cm	=	3/16"
Max. distance of net height			
From side line to center	2 cm	=	3/4"
Min. temperature	10° C	=	50° F
Weight range of ball	260-280 gm	=	0.5-0.6 lb
Internal air pressure			
of ball (indoor)	0.30-0.325 kg/cm ²	=	4.3-4.6 lb/sq in
Internal air pressure			
of ball (outdoor)	0.175-0.225 kg/cm ²	=	2.5-3.2 lb/sq

INDEX

INDOOR RULES

A

Actions involving the Libero	46
Additional Equipment	9
USAV 2.6	9
Antennae	8
Application of misconduct sanctions	53
Assistant Coach	18
USAV 5.3.1	18
Attack hit	34
Authorization of the service	31
USAV 12.3	32

B

Ball at the net	28
Ball crossing the net	28
USAV 10.1.2	29
Ball “in”	25, 79, 83
Ball in play	25
Ball in the net	29
Ball “out”	25, 79, 83
USAV 8.4.2	25
Ball out of play	25
USAV 8.2	25
Ball touching the net	29
Balls	9
Block	35, 72
Block contact	36
USAV 14.2	36
Blocking	35, 79
Block and team hits	36
Blocking faults	36
USAV 14.6	37
Blocking the service	36
Blocking within the opponent’s space	36
USAV 14.3	36

C

Captain	15
USAV 5.1.1, 5.1.2, 5.1.2.1	15
Change of courts	45, 76
Change of equipment	13
USAV 4.3, 4.3.1, 4.3.3, 4.3.3.1	13
USAV 4.3.3.2	14
Characteristics of the attack hit.	34
Characteristics of the hit	28
Coach	17
USAV 5.2.2, 5.2.3	17
USAV 5.2.3.4	18
Contact with the net	30

D

Default and incomplete team	20
USAV 6.4	20
Delay sanctions	43
Designation of the Libero	46
USAV 19.1.1	46
Dimensions.	4
USAV 1.1a, 1.1b	4

E

Equipment.	13, 46
USAV 4.3, 4.3.1, 4.3.3, 4.3.3.1	13
Exceptional game interruption	43
Exceptional substitution	40
USAV 15.7a	40
Execution of the service	32
USAV 12.4.3, 12.4.4, 12.4.5	32
External interference.	44
USAV 17.2	44

F

Fair play	51
Faults in playing the ball	28
Faults made during the service.	33
USAV 12.6.2, 12.6.1.2	33
Faults of the attack hit.	35
USAV 13.3	35
First Referee.	56
–Authority	56
–Location	56
First service in a set	31

F (cont.)

Five-ball system	10
USAV 3.3	10
Forbidden objects	14
USAV 4.5.1, 4.5.2	14

G

Game delays	43
USAV 16.1	43
Game interruptions	38, 43
USAV 15.2, 15.3.1, 15.3.2	38
USAV 17.1.1	43

H

Height of the net	7
USAV 2.1	7

I

Illegal substitution	41
USAV 15.9.1, 15.9.2.3	41
Improper request	42
USAV 15.11, 15.11.2	42
Injury/Illness	43
USAV 17.1.1	43
Interruptions	38
Intervals	45
Intervals and change of courts	45

L

Libero Player	46
Lighting	7
USAV 1.6	7
Limitation of substitutions	39
USAV 15.6	39
Line judges	63, 83-84
USAV 27.1	63
Line judges' flag signals	64, 83-84
–Location	63
USAV 27.1	63
–Responsibilities	63
Lines on the court	5
USAV 1.3.1, 1.3.4	5
Location of the team	12
USAV 4.2.4	12

M	
Minor misconduct	51
Misconduct and its sanctions	51
Misconduct before and between sets	53
Misconduct leading to sanctions	52
N	
Net and posts	7
Number of regular game interruptions	38
USAV 15.1, 15.6	38
O	
Official signals	64, 76-82, 83-84
Official warm-up session	21
USAV 7.2.2	21
P	
Players' faults at the net	30
Playing area	4, 66
Playing surface	4
USAV 1.2.1, 1.2.2	4
Playing the ball	26
USAV 9	26
Positions	23
USAV 7.4.3	23
Positional fault	24
Posts	8
USAV 2.5.2, 2.6	9
Prolonged interruptions	44
USAV 17.3.2, 17.3.2.2	44
R	
Reaching beyond the net	29, 81
Refereeing corps	55, 75
–Procedures	55
USAV 22.2.1	55
–Responsibilities	57, 59, 60, 63
Referees' hand signals	64, 76-82
Request for regular game interruptions	38
USAV 15.3.1, 15.3.2	38
Requirements of conduct	51
USAV 20.1.1	51
Restrictions of the attack hit	34

R (cont.)

Rotation 24
Rotational fault 24, 79
 USAV 7.7.1 79

S

Sanction cards 54, 74, 77, 78
Sanction scales 52, 74
Scorer 60
–Location 60
–Responsibilities 60
 USAV 25.2.1.1 60
Screening 33, 79
 USAV 12.5.2 33
Second Referee 58
–Authority 58
 USAV 24.2.6, 24.2.7 59
–Location 58
–Responsibilities 59
 USAV 24.3.1 59
 USAV 24.3.3, 24.3.2.3, 24.3.2.4 60
Service 31
Service order 31
Sequence of regular game interruptions 38
 USAV 15.2 38
Serving faults and positional faults 34
Side bands 8
 USAV 2.3 8
Sportsmanlike conduct 51
 USAV 20.1.1 51
Standards 9
States of play 25
Structure 7
 USAV 2.2 7
Structure of play 20
Substitution 39
Substitution for expulsion or disqualification 40
Substitution procedure 41
 USAV 15.10.4 42

T

Teams	11
Team composition	11
USAV 4.1.1, 4.1.3	11
Team leaders	15
USAV 5.5	15
Team hits	27, 36
USAV 9.1.2.1	27
Team starting line-up	21
USAV 7.3.1, 7.3.2	22
Temperature	7
The Libero Player	46
The toss	20
Three-ball system (USAV 3.3)	10
Time-out and Technical Time-out	38
To score a point	19
To score a point, win a set and the match	19
To win a set.	19
To win the match.	20
USAV 6.3	20
Types of delays.	43
USAV 16.1	43

U

Uniformity of balls	10
USAV 3.2	10

Z

Zones and areas.	6
USAV 1.4.2, 1.4.5, 1.4.6	6

U-VOLLEY RULES

Height Restrictions	87
-------------------------------	----

CO-ED RULES RULE/COMMENTARY/HAND SIGNAL

Blocker, Back-row (R1.4)	88
Fault, Double (R1.2.3)	88
Hit, Illegal (R1.2.3)	88
Service Order (R1.1).	87
Team Hit, More Than One (R1.2)	87
Net, Height (R1.5).	88
Reverse Co-ed (R2)	88



USAVolleyball®

Education

COACH - koch/n

1: one who instructs or trains performers (Webster's).

2: all volunteers, teachers, players, people who administer, guide, create, inspire any athlete or person to compete and enjoy the skills, tactics, and interaction of volleyball.

The USA Volleyball Coaching Accreditation Program (USAV-CAP) provides an opportunity for professional preparation and advancement for the volleyball coach. The curriculum addresses the essential topics for the volunteer and the internationally aspiring coach.

Any player who enters a volleyball program has the right to expect quality coaching and instruction. USA Volleyball's CAP program strives to present an ongoing, progressive format in which coaches at all levels receive the most current information available on volleyball. USAV-CAP instruction is based on sound principles in the areas of skills development, tactical systems, physical training, motor learning, sports psychology and administration.

USAV-CAP is a continuous education process due to the dynamic nature of sport and technology. The four solid corners of the program are **integrity, education, commitment and enthusiasm.**

These are the qualities of any successful coach and program.

Your Success is our Goal!

For more information call **1-88USVOLLEY** or visit our web site at **www.usavolleyball.org**



USAVolleyball®

**For All Your Officiating Needs,
Contact USA Volleyball:**

USAV New Score Sheet Layout	\$5.00
USAV Condensed Layout Score Sheets	\$10.00
Line-Up Sheets (pad of 50)	\$10.00
2015-17 Domestic Competition Regulations (Rulebook)	\$6.95
Libero Tracking Sheets (pad of 50)	\$5.00

Prices do not include shipping & handling.

Phone: (512) 479-5130

(Between 9 a.m. and 5 p.m. Central)

E-mail: em2sports@yahoo.com